

Scalers and Scan Converters

DVS 510 Series

Switching Scalers



Extron Electronics
INTERFACING, SWITCHING AND CONTROL

Safety Instructions

Safety Instructions • English

WARNING: This symbol, , when used on the product, is intended to alert the user of the presence of uninsulated dangerous voltage within the product's enclosure that may present a risk of electric shock.

ATTENTION: This symbol, , when used on the product, is intended to alert the user of important operating and maintenance (servicing) instructions in the literature provided with the equipment.

For information on safety guidelines, regulatory compliances, EMI/EMF compatibility, accessibility, and related topics, see the Extron Safety and Regulatory Compliance Guide, part number 68-290-01, on the Extron website, www.extron.com.

Sicherheitsanweisungen • Deutsch

WARNUNG: Dieses Symbol , auf dem Produkt soll den Benutzer darauf aufmerksam machen, dass im Inneren des Gehäuses dieses Produktes gefährliche Spannungen herrschen, die nicht isoliert sind und die einen elektrischen Schlag verursachen können.

VORSICHT: Dieses Symbol , auf dem Produkt soll dem Benutzer in der im Lieferumfang enthaltenen Dokumentation besonders wichtige Hinweise zur Bedienung und Wartung (Instandhaltung) geben.

Weitere Informationen über die Sicherheitsrichtlinien, Produkthandhabung, EMI/EMF-Kompatibilität, Zugänglichkeit und verwandte Themen finden Sie in den Extron-Richtlinien für Sicherheit und Handhabung (Artikelnummer 68-290-01) auf der Extron-Website, www.extron.com.

Instrucciones de seguridad • Español

ADVERTENCIA: Este símbolo, , cuando se utiliza en el producto, avisa al usuario de la presencia de voltaje peligroso sin aislar dentro del producto, lo que puede representar un riesgo de descarga eléctrica.

ATENCIÓN: Este símbolo, , cuando se utiliza en el producto, avisa al usuario de la presencia de importantes instrucciones de uso y mantenimiento recogidas en la documentación proporcionada con el equipo.

Para obtener información sobre directrices de seguridad, cumplimiento de normativas, compatibilidad electromagnética, accesibilidad y temas relacionados, consulte la Guía de cumplimiento de normativas y seguridad de Extron, referencia 68-290-01, en el sitio Web de Extron, www.extron.com.

Instructions de sécurité • Français

AVERTISSEMENT : Ce pictogramme, , lorsqu'il est utilisé sur le produit, signale à l'utilisateur la présence à l'intérieur du boîtier du produit d'une tension électrique dangereuse susceptible de provoquer un choc électrique.

ATTENTION : Ce pictogramme, , lorsqu'il est utilisé sur le produit, signale à l'utilisateur des instructions d'utilisation ou de maintenance importantes qui se trouvent dans la documentation fournie avec le matériel.

Pour en savoir plus sur les règles de sécurité, la conformité à la réglementation, la compatibilité EMI/EMF, l'accessibilité, et autres sujets connexes, lisez les informations de sécurité et de conformité Extron, réf. 68-290-01, sur le site Extron, www.extron.com.

Istruzioni di sicurezza • Italiano

AVVERTENZA: Il simbolo, , se usato sul prodotto, serve ad avvertire l'utente della presenza di tensione non isolata pericolosa all'interno del contenitore del prodotto che può costituire un rischio di scosse elettriche.

ATTENZIONE: Il simbolo, , se usato sul prodotto, serve ad avvertire l'utente della presenza di importanti istruzioni di funzionamento e manutenzione nella documentazione fornita con l'apparecchio.

Per informazioni su parametri di sicurezza, conformità alle normative, compatibilità EMI/EMF, accessibilità e argomenti simili, fare riferimento alla Guida alla conformità normativa e di sicurezza di Extron, cod. articolo 68-290-01, sul sito web di Extron, www.extron.com.

Instrukcje bezpieczeństwa • Polska

OSTRZEŻENIE: Ten symbol, , gdy używany na produkt, ma na celu poinformować użytkownika o obecności izolowanego i niebezpiecznego napięcia wewnątrz obudowy produktu, który może stanowić zagrożenie porażenia prądem elektrycznym.

UWAGI: Ten symbol, , gdy używany na produkt, jest przeznaczony do ostrzegania użytkownika ważne operacyjne oraz instrukcje konserwacji (obslugi) w literaturze, wyposażone w sprzęt.

Informacji na temat wytycznych w sprawie bezpieczeństwa, regulacji wzajemnej zgodności, zgodność EMI/EMF, dostępności i Tematy pokrewne, zobacz Extron bezpieczeństwa i regulacyjnego zgodności przewodnik, część numer 68-290-01, na stronie internetowej Extron, www.extron.com.

Инструкция по технике безопасности • Русский

ПРЕДУПРЕЖДЕНИЕ: Данный символ, , если указан на продукте, предупреждает пользователя о наличии неизолированного опасного напряжения внутри корпуса продукта, которое может привести к поражению электрическим током.

ВНИМАНИЕ: Данный символ, , если указан на продукте, предупреждает пользователя о наличии важных инструкций по эксплуатации и обслуживанию в руководстве, прилагаемом к данному оборудованию.

Для получения информации о правилах техники безопасности, соблюдении нормативных требований, электромагнитной совместимости (ЭМП/ЭДС), возможности доступа и других вопросах см. руководство по безопасности и соблюдению нормативных требований Extron на сайте Extron: www.extron.com, номер по каталогу - 68-290-01.

安全说明 • 简体中文

警告:  产品上的这个标志意在警告用户该产品机壳内有暴露的危险电压，有触电危险。

注意:  产品上的这个标志意在提示用户设备随附的用户手册中有重要的操作和维护(维修)说明。

关于我们产品的安全指南、遵循的规范、EMI/EMF 的兼容性、无障碍使用的特性等相关内容，敬请访问 Extron 网站: www.extron.com, 参见 Extron 安全规范指南, 产品编号 68-290-01。

安全記事・繁體中文

警告: ⚠ 若產品上使用此符號，是為了提醒使用者，產品機殼內存在著可能會導致觸電之風險的未絕緣危險電壓。

注意: ⚠ 若產品上使用此符號，是為了提醒使用者，設備隨附的用戶手冊中有重要的操作和維護（維修）說明。

有關安全性指導方針、法規遵守、EMI/EMF 相容性、存取範圍和相關主題的詳細資訊，請瀏覽 Extron 網站：www.extron.com，然後參閱《Extron 安全性與法規遵守手冊》，準則編號 68-290-01。

安全上のご注意・日本語

警告: この記号 ⚠ が製品上に表示されている場合は、筐体内に絶縁されていない高電圧が流れ、感電の危険があることを示しています。

注意: この記号 ⚠ が製品上に表示されている場合は、本機の取扱説明書に記載されている重要な操作と保守（整備）の指示についてユーザーの注意を喚起するものです。

安全上のご注意、法規遵守、EMI/EMF適合性、その他の関連項目については、エクストロンのウェブサイト www.extron.com より『Extron Safety and Regulatory Compliance Guide』(P/N 68-290-01) をご覧ください。

안전 지침・한국어

경고: 이 기호 ⚠ 가 제품에 사용될 경우, 제품의 인클로저 내에 있는 접지되지 않은 위험한 전류로 인해 사용자가 감전될 위험이 있음을 경고합니다.

주의: 이 기호 ⚠ 가 제품에 사용될 경우, 장비와 함께 제공된 책자에 나와 있는 주요 운영 및 유지보수(정비) 지침을 경고합니다.

안전 가이드라인, 규제 준수, EMI/EMF 호환성, 접근성, 그리고 관련 항목에 대한 자세한 내용은 Extron 웹 사이트(www.extron.com)의 Extron 안전 및 규제 준수 안내서, 68-290-01 조항을 참조하십시오.

Copyright

© 2017 Extron Electronics. All rights reserved.

Trademarks

All trademarks mentioned in this guide are the properties of their respective owners.

The following registered trademarks[®], registered service marksSM, and trademarksTM are the property of RGB Systems, Inc. or Extron Electronics (see the current list of trademarks on the [Terms of Use](#) page at www.extron.com):

Registered Trademarks[®]

Cable Cubby, ControlScript, CrossPoint, DTP, eBUS, EDID Manager, EDID Minder, Extron, Flat Field, FlexOS, FOX, Global Configurator, Global Scriptor, GlobalViewer, Hideaway, IP Intercom, IP Link, Key Minder, LinkLicense, LockIt, MediaLink, MediaPort, NetPA, PlenumVault, PoleVault, PowerCage, PURE3, Quantum, SoundField, SpeedMount, SpeedSwitch, System *INTEGRATOR*, TeamWork, TouchLink, V-Lock, VideoLounge, VN-Matrix, VoiceLift, WallVault, WindoWall, XTP, and XTP Systems

Registered Service MarkSM : S3 Service Support Solutions

TrademarksTM

AAP, AFL (Accu-Rate Frame Lock), ADSP (Advanced Digital Sync Processing), Auto-Image, CableCover, CDRS (Class D Ripple Suppression), Codec Connect, DDSP (Digital Display Sync Processing), DMI (Dynamic Motion Interpolation), Driver Configurator, DSP Configurator, DSVP (Digital Sync Validation Processing), eLink, Entwine, EQIP, EverLast, FastBite, FOXBOX, HyperLane, IP Intercom HelpDesk, MAAp, MicroDigital, Opti-Torque, ProDSP, QS-FPC (QuickSwitch Front Panel Controller), Room Agent, Scope-Trigger, ShareLink, SIS, Show Me, Simple Instruction Set, Skew-Free, SpeedNav, StudioStation, Triple-Action Switching, True4K, Vector 4K, WebShare, XTRA, ZipCaddy, and ZipClip

FCC Class A Notice

This equipment has been tested and found to comply with the limits for a Class A digital device, pursuant to part 15 of the FCC rules. The Class A limits provide reasonable protection against harmful interference when the equipment is operated in a commercial environment. This equipment generates, uses, and can radiate radio frequency energy and, if not installed and used in accordance with the instruction manual, may cause harmful interference to radio communications. Operation of this equipment in a residential area is likely to cause interference. This interference must be corrected at the expense of the user.

NOTES:

- This unit was tested with shielded I/O cables on the peripheral devices. Shielded cables must be used to ensure compliance with FCC emissions limits.
- For more information on safety guidelines, regulatory compliances, EMI/EMF compatibility, accessibility, and related topics, see the [Extron Safety and Regulatory Compliance Guide](#) on the Extron website.

Battery Notice

This product contains a battery. Do not open the unit to replace the battery. If the battery needs replacing, return the entire unit to Extron (for the correct address, see the Extron Warranty section on the last page of this guide).

CAUTION: Risk of explosion. Do not replace the battery with an incorrect type. Dispose of used batteries according to the instructions.

ATTENTION : Risque d'explosion. Ne pas remplacer la pile par le mauvais type de pile. Débarrassez-vous des piles usagées selon le mode d'emploi.

VCCI-A Notice

この装置は、クラスA 情報技術装置です。この装置を家庭環境で使用すると、電波妨害を引き起こすことがあります。その場合には使用者が適切な対策を講ずるよう要求されることがあります。

VCCI-A

Conventions Used in this Guide

Notifications

The following notifications are used in this guide:

CAUTION: Risk of minor personal injury.

ATTENTION : Risque de blessure mineure.

ATTENTION:

- Risk of property damage.
- Risque de dommages matériels.

NOTE: A note draws attention to important information.

TIP: A tip provides a suggestion to make working with the application easier.

Software Commands

Commands are written in the fonts shown here:

```
^ARMerge Scene , ,Op1 scene 1,1 ^B 51 ^W^C  
[ 01 ] R 0004 00300 00400 00800 00600 [ 02 ] 35 [ 17 ] [ 03 ]
```

NOTE: For commands and examples of computer or device responses mentioned in this guide, the character “0” is used for the number zero and “O” is the capital letter “o.”

Computer responses and directory paths that do not have variables are written in the font shown here:

```
Reply from 208.132.180.48: bytes=32 times=2ms TTL=32  
C:\Program Files\Extron
```

Variables are written in slanted form as shown here:

```
ping xxx.xxx.xxx.xxx -t  
SOH R Data STX Command ETB ETX
```

Selectable items, such as menu names, menu options, buttons, tabs, and field names are written in the font shown here:

```
From the File menu, select New.  
Click the OK button.
```

Specifications Availability

Product specifications are available on the Extron website, www.extron.com.

Extron Glossary of Terms

A glossary of terms is available at <http://www.extron.com/technology/glossary.aspx>.



Contents

Introduction 1

About this Guide	1
The DVS 510 Series Scalers	1
Features	2
Controlling the DVS 510 Series	4
Application Diagram	5

Installation 6

Installation Overview	6
Rear Panel.....	7
Connecting to the RS-232 CONFIG Port (Front Panel)	11
Wiring the Amplified Audio Port (DVS 510 SA Only).....	12

Operation 14

Front Panel.....	14
Powering On	17
Picture-in-Picture (PIP) Mode.....	18
Enabling PIP Mode	19
Changing the PIP Input.....	19
Using the PIP Swap Feature	19
Menus on the LCD Screen	20
Menu System Overview	20
User Presets Menu	22
Input Configuration Menu	23
Output Configuration Menu.....	26
Audio Configuration Menu	28
Advanced Configuration Menu.....	29
View Comm Settings Menu	34
Edit Comm Settings Menu.....	34
Exiting the Menu System	36
Picture Controls.....	37
Adjusting the Picture Controls.....	37
Picture Controls Summary	38
Input Presets	39
Audio Functions.....	39
Volume Control.....	40
Audio or Video Breakaway.....	41

Resetting	41
Front Panel Lockout (Executive Mode).....	43
Additional Features.....	43
Freeze	43
Power Save Modes	43
Output Sync Mute	44
Overscan Mode.....	44
Using the Optional IR 904 Remote Control	44
Locking IR Remote Control Access	45
Installing Batteries in the IR 904 Remote Control	45
Buttons on the IR 904 Remote Control	45

Remote Configuration and Control..... 48

Serial Ports.....	48
Ethernet Port	48
Ethernet Cable.....	48
IP Address.....	49
Establishing an Ethernet Connection Using TCP	49
Connection Timeouts	49
Using SIS Commands	49
Scaler-initiated Messages	50
Error Responses.....	50
Using the Command and Response Tables.....	51
Symbol Definitions for DVS 510 Series SIS Commands	52
Command and Response Table for DVS 510 Series SIS Commands.....	57
Symbol Definitions for IP-specific SIS Commands	69
Command and Response Table for IP-Specific SIS Commands.....	73
Using the Signal Processing Products Control Program (SPPCP).....	81
Installing the Software.....	81
Starting the Software	82
Accessing the Help File.....	83
Updating the Firmware Using SPPCP	84

HTML Configuration and Control 87

- Accessing the Web Pages 87
- Special Characters 88
- System Status Page 89
- Configuration Pages 90
 - System Settings Page 90
 - Scaler Settings Page 93
 - Passwords Page..... 96
 - Firmware Upgrade Page 97
- File Management Page 99
 - Uploading Files 99
 - Adding a Directory 100
 - Other File Management Activities 100
- Control Pages..... 100
 - User Control Page 101
 - Memory/Input Presets Page 104
 - PIP Setup Page 106

Reference Information 109

- Mounting the DVS 510 Scaler..... 109
 - Rack Mounting 109
 - Tabletop Use 110
- Button Labels 110
 - Replacing Button Labels..... 110
 - Creating Labels Using the Button Label Generator 111
 - Blank Button Labels 113
- IP Addressing 114
 - What is an IP Address?..... 114
 - Choosing IP Addresses 114
 - Subnet Mask 115
 - Pinging for the IP Address 115
 - Connecting as a Telnet Client..... 116
 - Subnetting, a Primer 118

Extron Warranty 120

- Warranty 120
- Contact Information 120

Introduction

This section gives an overview of the DVS 510 and DVS 510 SA scalers. Topics include:

- [About this Guide](#)
- [The DVS 510 Series Scalers](#)
- [Features](#)
- [Controlling the DVS 510 Series](#)
- [Application Diagram](#)

About this Guide

This guide contains information about the Extron DVS 510 Series of switching scalers with instructions for experienced installers on how to install, configure, and operate the equipment.

In this guide, the terms “DVS,” “DVS 510,” and “scaler” are used interchangeably to refer to DVS 510 and the DVS 510 SA scalers.

The DVS 510 Series Scalers

The Extron DVS 510 Series scalers are 10-input, multi-format presentation switching scalers that accept and scale DVI, RGB, YUVp/HDTV, YUVi, S-video, and composite video signals to a common, high resolution output rate. With simultaneous DVI and two analog RGB/YUV outputs, the DVS 510 can integrate analog and digital video devices, and HDCP compliance enables integration of Blu-ray Disc players and cable or satellite HD receivers. The DVS 510 also offers flexible control options, including front panel controls, Ethernet, RS-232 or RS-422, and infrared (IR).

The DVS 510 also includes 10-input stereo audio switching to accompany incoming video sources. Gain and attenuation adjustment is provided for each input, and the DVS 510 provides master volume control on the front panel. Also included are bass and treble controls, as well as integrated audio delay to maintain audio sync with the processed video output.

The DVS 510 is available in two configurations: the standard DVS 510, which offers fixed and variable line level audio outputs, and the DVS 510 SA, which adds an integrated stereo amplifier with 25 watts rms output per channel into 4 or 8 ohms.

Features

The DVS 510 provides the following features:

- **Video upscaling and downscaling** — DVI, RGB computer video, high definition video, and standard definition video sources can all be scaled to the desired output resolution. The DVS 510 scaling engine provides high quality upscaling and downscaling of high resolution computer video signals.
- **High Performance Video Processing** — A high performance 30-bit scaling engine is able to scale standard definition video, HDTV, and RGB signals up or down in resolution. It accepts computer video signals up to 1920x1200 and HDTV 1080p/60. It outputs DVI and analog RGB or component video at selectable output rates from 640x480 to 1920x1200 resolution and HDTV rates of up to 1080p/60.
- **EDID Minder** — The Extron EDID Minder automatically manages the Extended Display Identification Data (EDID) for all the DVI and VGA input sources. By default, VGA and DVI input EDIDs match the current output resolution of the scaler. Also available is a user assigned mode, which allows pre-stored EDID, based on a user selected resolution, to be manually assigned to the sources. By maintaining continuous EDID communication with all sources, EDID Minder ensures that all DVI and VGA sources power up properly and maintain their video outputs whether or not they are actively connected to the display device through the scaler outputs.
- **Inputs** — The DVS 510 has two composite video inputs on BNC connectors, two S-video inputs on 4-pin mini DIN connectors, two RGB/YUV inputs on 15-pin HD connectors, and two digital and two analog RGB/YUV inputs on DVI-I connectors. Stereo balanced and unbalanced audio for each input is provided on 3.5 mm, 5-pole captive screw connectors
- **Outputs** — The DVS 510 has a scaled DVI-D video output on a DVI-I connector, two scaled RGB/YUV outputs on 15-pin HD connectors, and two audio outputs (one fixed and one variable) providing balanced and unbalanced stereo audio on 3.5 mm 5-pole captive screw connectors. The DVS 510 SA also has an amplified output on a 5 mm, 4-pole captive screw connector.
- **Simultaneous DVI and analog RGB or HD component video outputs** — A DVI-D and two analog RGB/YUV outputs are provided for driving up to three display devices.
- **Selectable output rates** — Available output rates include computer video up to 1920x1200, HDTV rates up to 1080p/60, and 2048x1080.
- **HDCP compliance** — The DVS 510 fully supports HDCP-encrypted signals.
- **Active HDCP verification** — The DVS 510 provides real-time verification of HDCP status for each DVI input and output. This allows for quick signal and HDCP verification through RS-232/RS-422 or Ethernet.
- **HDCP Visual Confirmation** — The DVS 510 outputs a full-screen green signal and an on-screen message when an HDCP compliant source is routed to a non-HDCP compliant display, providing immediate visual confirmation that protected content cannot be viewed on the selected display.
- **Image freeze control** — A live image can be frozen through RS-232 or RS-422 serial control and through Ethernet control.
- **Auto-Image setup** — Enables the DVS 510 to automatically analyze the incoming video signal for each input and adjust sizing, centering, and filtering to optimize image quality. This can save time and effort in fine tuning displayed images.
- **Auto memories** — Enables the DVS 510 to store size, position, and picture settings based on the incoming signal. When the same signal is detected again, these image settings are recalled from memory.

- **PIP (picture-in-picture)** — Allows a video source to be displayed within a high resolution image, or vice versa. Audio switching can be set to follow either the main or PIP window.
- **Glitch-free switching** — Switching between sources occurs without distortions or glitches with selectable cut or fade-to-black transitions.
- **Customizable front panel control buttons** — The tricolored, backlit pushbuttons on the front panel can be custom-labeled.
- **Power Save Mode** — The DVS 510 can be set to mute video and sync output to the display device when no active input signal is detected. This allows the projector or flat-panel display to automatically enter into standby mode to save energy and enhance lamp or panel life.
- **HDMI signals support** — When used with optional Extron HDMI-DVI adapters, the DVI inputs and output on the DVS 510 are compatible with HDMI. The DVS 510 fully passes audio and auxiliary data as part of the HDMI signal, ensuring audio and video compatibility with downstream HDMI-equipped devices.
- **Audio switching and output volume control** — The DVS 510 features audio switching for 10 stereo balanced or unbalanced input sources, and provides master volume control and muting as well as bass and treble controls. Fixed and variable line level outputs are available, and each output can be balanced or unbalanced. Stereo input signals can be output as dual mono.
- **Audio or video breakaway** — Lets you break an audio signal away from its corresponding video signal and route it to the audio outputs, allowing the audio channels to be operated as a separate scaler.
- **Integrated audio delay** — Delays the audio output automatically to compensate for latency introduced by the video processing.
- **Amplifier (DVS 510 SA only)** — The DVS 510 SA has a stereo power amplifier with 25 watts rms per channel into 4 or 8 ohms. The Class D amplifier design includes CDRS™ – Class D Ripple Suppression, an Extron patented technology that provides a smooth, clean audio waveform and an improvement in signal fidelity over conventional Class D amplifier designs. CDRS eliminates the high frequency switching ripple characteristic of Class D amplifiers, a source of RF emissions that can interfere with sensitive AV equipment such as wireless microphones.
- The DVS 510 SA includes technology for the integrated amplifier that detects the onset of clipping by comparing input and output signals. Gain is reduced with a slow attack and fast release to eliminate clipping and protects the speakers from clipping distortion.
- **Picture controls** — Brightness, contrast, color, tint, detail, horizontal and vertical positioning, sizing, and zoom can be set. 16 user memory presets are available for each input to store all image settings.
- **Automatic 3:2 and 2:2 pulldown detection** — Advanced film mode processing techniques help maximize image detail and sharpness for NTSC, PAL, and HDTV 1080i sources that originated from film.
- **Motion adaptive 1080i deinterlacing** — High performance deinterlacing is provided for 1080i signals from HD sources, including cable or satellite set-top devices, delivering optimized image quality through advanced motion compensation.
- **Aspect ratio control** — The output can be designated to meet a specific aspect ratio requirement so that the image fills the screen, or is displayed with compensation for the native aspect ratio of the source.
- **Quad standard video decoding** — A digital, four-line adaptive comb filter decodes NTSC 3.58, NTSC 4.43, PAL, and SECAM for integration into systems worldwide.

- **Test patterns** — 12 test patterns are provided for calibration and setup, including a crop pattern, crosshatch, 16 bar grayscale, color bars, alternating pixels, ramp, white field, 4 x 4 crosshatch, and four aspect ratio patterns (1.33, 1.78, 1.85, and 2.35).
- **Front panel security lockout (executive mode)** — When enabled, locks out all front panel functions except for input selection (all functions remain available through RS-232, RS-422, or IR remote control).
- **Optional IR remote control** — The optional Extron IR 904 handheld remote control provides an additional method of input source switching, picture-in-picture, and direct access to picture adjustments.
- **Ethernet monitoring and control** — The DVS 510 can be controlled and proactively monitored over a LAN, WAN, or the Internet. Embedded web pages are included for such common functions as input switching, volume control, and system configuration.
- **RS-232 and RS-422 control** — The DVS 510 can be controlled and configured via Simple Instruction Set (SIS™) commands, a set of basic ASCII code commands that allow for quick and easy programming via RS-232 or RS-422.
- **Windows-based configuration and control software** — The Signal Processing Products Control Program (SPPCP) can be used to configure and control the DVS 510 via RS-232, RS-422, or Ethernet.
- **Rack-mountable 2U, full rack width metal enclosure**
- **Internal universal power supply** — The 100-240 VAC, 50-60 Hz, international power supply provides worldwide power compatibility.

Controlling the DVS 510 Series

You can control the DVS 510 and the DVS 510 SA using one or more of the following methods:

- The front panel controls include back-lit buttons, a Volume Control knob, and rotary Adjustment encoders.
- A computer, a touch screen panel, or any other device that can send and receive serial communications through the RS-232/RS-422 or Ethernet port enables the following controls:
 - The Extron Simple Instruction Set (SIS) is a set of simple keystroke commands that can be used with any RS-232 or RS-422 device.
 - The Extron Windows-based control software provides a graphical interface for controlling the scaler from a computer.
 - The embedded web pages enable HTML control of the DVS from a computer.
- The optional IR 904 remote control, part number 70-767-01, replicates most of the front panel controls

Application Diagram

The following diagram shows an example of a DVS 510 SA application.

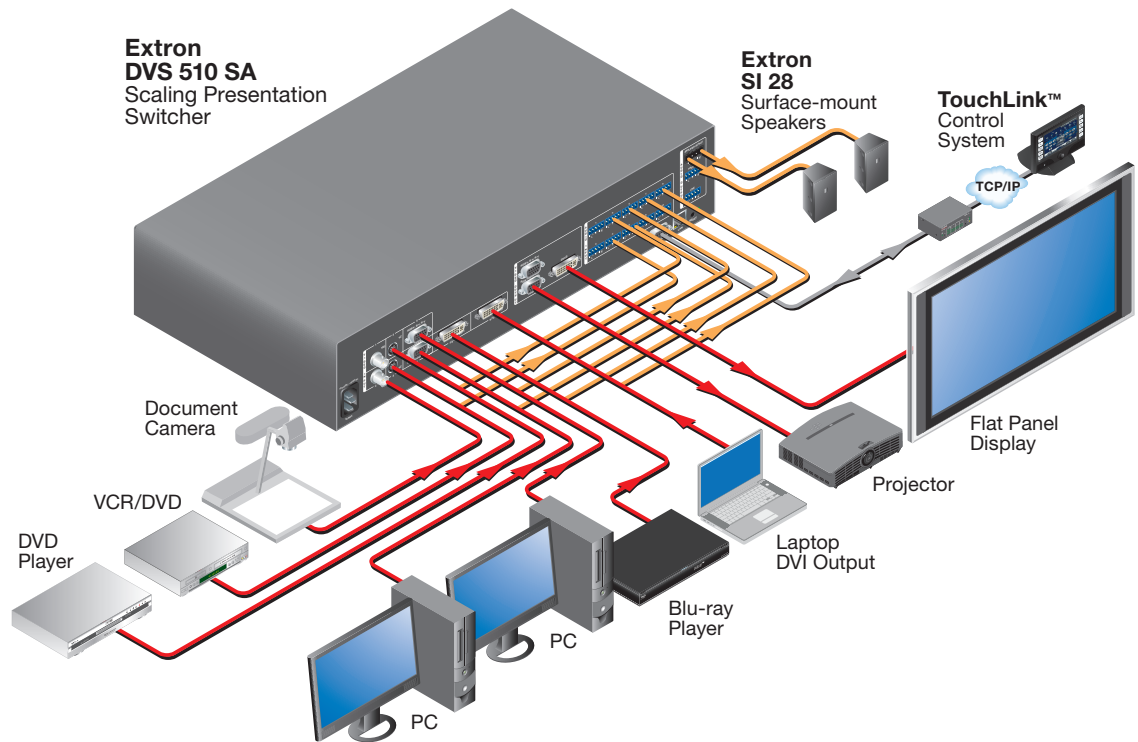

Figure 1. Connection Diagram for a DVS 510 SA

Installation

This section gives an overview of the steps to installing the DVS 510. It also provides a description of the rear panel connectors and instructions for cabling. This section includes the following topics:

- [Installation Overview](#)
- [Rear Panel](#)
- [Connecting to the RS-232 CONFIG Port \(Front Panel\)](#)
- [Wiring the Amplified Audio Ports \(DVS 510 SA Only\)](#)

Installation Overview

Follow these steps to install and set up the DVS 510:

1. Disconnect power from the scaler and turn off all other devices to be connected to it.
2. (Optional) Mount the unit in a rack (see [Mounting the DVS 510 Scaler](#) on page 109).
3. Connect video and audio sources and outputs:
 - Connect video input devices to the applicable connectors on the rear panel, **Video Input** panel (see [figure 2](#), **B** through **E**, on the next page).
 - Connect video output devices to the appropriate connectors in the **Video Output** panel (**F** and **G**).
 - Connect audio input devices to the appropriate captive screw connectors in the **Audio Input** panel (**H**).
 - Connect audio output devices to the 5-pole Variable (**J**) and Fixed (**K**) captive screw audio connectors in the **Audio Output** panel as desired. On the DVS 510 SA, you can connect speakers or another output device to the internal amplifier through the 4-pole Amplified connector (**I**).
4. Connect control devices as desired:

LAN Ethernet port — Connect the DVS to an Ethernet LAN or WAN via this RJ-45 connector (**N**) to control the scaler from a remote location, using an Internet browser on a computer.

RS-232 port — For serial RS-232 or RS-422 control, connect a host computer or control system to the DVS via the 9-pin D-sub connector (**O**).

Protocol (default values) for this port is:

- 9600 baud
- 8 data bits
- 1 stop bit
- no parity
- no flow control

NOTE: See [Remote Configuration and Control](#), beginning on page 48, for definitions of the SIS commands and for instructions for installing and starting the Signal Processing Products Control Program (SPPCP).

5. Connect power to the DVS by plugging a standard IEC power cord (provided) from a 100-240 VAC, 50-60 Hz AC power source into the power receptacle (see **figure 2, A**).
6. Configure the DVS 510 using the SPPCP (see the control program help file), SIS commands (see **Remote Configuration and Control**, beginning on page 48), the internal web pages (see **HTML Configuration and Control**, beginning on page 87), or any combination of these methods.

Rear Panel

WARNING: Remove power from the system before making any connections.

AVERTISSEMENT : Mettez le système hors tension avant d'effectuer tout raccordement.

CAUTION: This unit uses double pole/neutral fusing.

ATTENTION : Cette unité utilise un système de fusible neutre/à double pôle.

ATTENTION:

- Use electrostatic discharge precautions (be electrically grounded) when making connections. Electrostatic discharge (ESD) can damage equipment, although you may not feel, see, or hear it.
- Prenez des précautions contre les décharges électrostatiques (soyez électriquement relié à la terre) lorsque vous effectuez des connexions. Les décharges électrostatiques (ESD) peuvent endommager l'équipement, même si vous ne pouvez pas le sentir, le voir ou l'entendre.

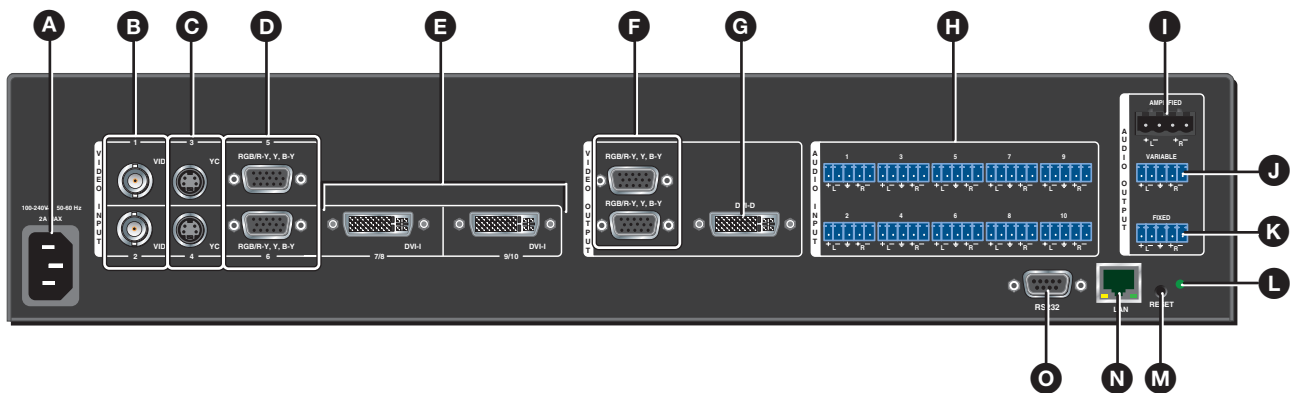

- | | |
|--|---|
| A AC power connector | I Amplified audio output connector |
| B Video inputs 1 and 2: Composite video | J Variable audio output connector |
| C Video inputs 3 and 4: S-video | K Fixed audio output connector |
| D Video inputs 5 and 6: Buffered RGB or YUV component | L Reset LED |
| E Video inputs 7/8 and 9/10 | M RESET button |
| F RGB/YUV output connectors | N LAN connector |
| G DVI-I output connector | O RS-232 connector |
| H Audio input connectors | |

Figure 2. DVS 510 SA Rear Panel

NOTE: The illustration above shows the rear panel of a DVS 510 SA. The DVS 510 rear panel is identical except that it does not have the amplified audio output connector (see figure 2, **i**).

- A AC power connector** — Plug a standard IEC power cord from a 100 to 240 VAC, 50 Hz or 60 Hz power source into this IEC connector.
- B Video inputs 1 and 2 — Composite video** — Connect one or two composite video sources to these female BNC connectors.
- C Video inputs 3 and 4 — S-video** — Connect one or two S-video sources to these female 4-pin mini-DIN connectors.
- D Video inputs 5 and 6 — Buffered RGB or YUV component** — Connect one or two RGBHV, RGBS, RGsB, RGBcvS, YUVi, or YUVp/HDTV video sources to these female 15-pin HD connectors (shown at right). These inputs feature EDID emulation.
- E Video inputs 7/8 and 9/10** — Connect two DVI, two RGB/YUV, or one each video sources to these DVI-I connectors. The analog portions of these connectors are identified as inputs 7 and 9, while the DVI portions are recognized as inputs 8 and 10. These connectors feature EDID emulation.

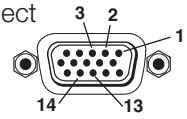

The following tables show the DVI-I connector pin assignments for DVI and analog source connection.

Digital Connections

Pin	Signal	Pin	Signal	Pin	Signal
1	TMDS data 2-	9	TMDS data 1-	17	TMDS data 0-
2	TMDS data 2+	10	TMDS data 1+	18	TMDS data 0+
3	TMDS data 2/4 shield	11	TMDS data 1/3 shield	19	TMDS data 0/5 shield
4	Not used	12	Not used	20	Not used
5	Not used	13	Not used	21	Not used
6	DDC clock	14	+5 V power	22	TMDS clock shield
7	DDC data	15	Ground	23	TMDS clock+
8	Not used	16	Hot plug detect	24	TMDS clock-

Analog Connections

Pin	Function
C1	Red signal
C2	Green signal
C3	Blue signal
C4	Horizontal sync
C5	Ground

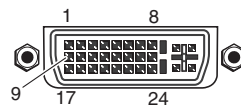
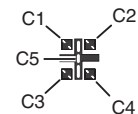

Figure 3. Pin Assignments for the DVI-I Connectors

- F RGB/YUV output connectors** — Connect cables from RGB (RGBHV, RGBS, RGsB) or YUVp/HD component (R-Y, Y, B-Y) display devices to these female 15-pin HD connectors for scaled RGB or component video output. The output can be scaled to 69 different output rates (see the [resolution and refresh rates table](#) on page 27).

NOTE: Outputs are buffered and can be connected simultaneously to two different displays. The sync and video formats are the same for all outputs.

- G DVI-I output connector** — Connect a digital (DVI-D) display device to this DVI-I connector for a scaled DVI output (analog output is not available on this connector). Figure 4 shows the pin assignments for the DVI output connector.

Pin	Signal	Pin	Signal	Pin	Signal
1	TMDS data 2-	9	TMDS data 1-	17	TMDS data 0-
2	TMDS data 2+	10	TMDS data 1+	18	TMDS data 0+
3	Ground (2/4)	11	Ground (1/3)	19	Ground (0/5)
4	Not used	12	Not used	20	Not used
5	Not used	13	Not used	21	Not used
6	DDC clock	14	+5 V power	22	Ground (clock)
7	DDC data	15	Ground (for 5 V)	23	TMDS clock+
8	Not used	16	Hot plug detect	24	TMDS clock-

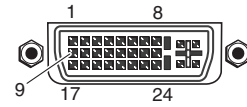

Figure 4. Pin Assignments for the DVI Output Connector

- H Audio input connectors** — Connect up to 10 audio input devices to these female 3.5 mm 5-pole captive screw connectors for balanced or unbalanced audio input. One audio input is provided for each video input.

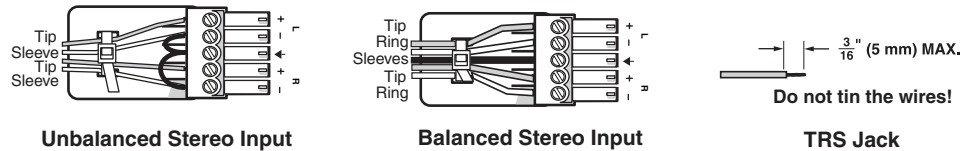

Figure 5. Audio Input Connector Wiring

- I Amplified audio output connector (DVS 510 SA only)** — This 4-pole, 5 mm captive screw connector enables you to connect a set of speakers or another output device to the DVS 510 SA internal amplifier for amplified output.

All right channel input signals are mixed and summed to produce a single, right channel output. Likewise, all left channel input signals are mixed and summed to produce a single, left channel output.

If Stereo is selected for the output type, the output is stereo. If Dual Mono is selected, the right and left channels are mixed and summed for a dual mono output.

With an 8 ohm load, the amplifier produces up to 8 watts per channel. With a 4 ohm load, the amplifier produces up to 25 watts per channel.

(See [Wiring the Amplified Audio Port \(DVS 510 SA Only\)](#) on page 12 for information on connecting speakers to this port.)

- J Variable audio output connector** — Connect an audio device to this female 5-pole 3.5 mm captive screw connector for balanced or unbalanced variable audio output. This output is affected by tone control, gain, attenuation, and audio delay. Wire the connector as shown below.

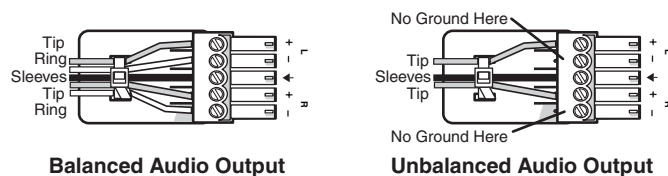
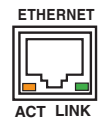

Figure 6. Audio Output Connector Wiring

- K Fixed audio output connector** — Connect an audio device to this female 5-pole 3.5 mm captive screw connector for balanced or unbalanced fixed audio output. This output is not affected by tone control; however, it is affected by gain, attenuation, and audio delay. Wire the connector as shown in **figure 6** on the previous page.
- L Reset LED** — This green LED lights steadily while power is on. While the RESET button is being pressed and held, it blinks the number of times to indicate the reset mode.
- M RESET button** — Using a small screwdriver, pointed stylus, or ballpoint pen, press this recessed button for manual resets. The unit has four modes of reset (see **Resetting** on page 41 for additional information).
- N LAN connector** — Plug an Ethernet cable into this RJ-45 jack to connect the unit to a computer network. Ethernet control allows you to configure and control the scaler from a remote location using SIS commands, the SPPCP software, or the embedded web pages. When connected to an Ethernet LAN or WAN, the DVS can be accessed and operated from a computer running a standard Internet browser.

Use a patch cable to connect the DVS to a switch, hub, or router. Use a straight-through cable to connect it directly to your computer. This connector contains two LEDs (see the illustration at right):



- Act LED — This amber LED blinks to indicate LAN signal activity.
- Link LED — This green LED lights steadily to indicate a LAN connection.

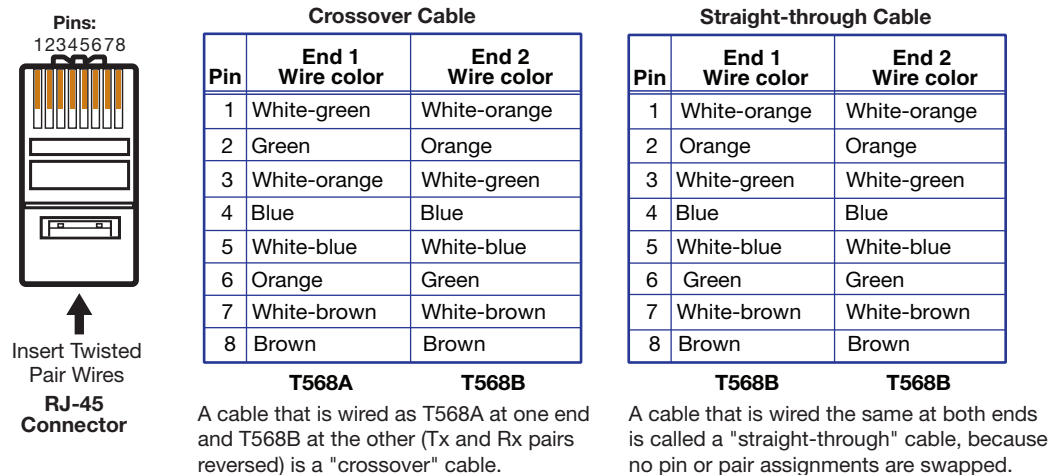

Figure 7. Wiring the LAN Connector

- RS-232 connector** — This female 9-pin DB-9 connector provides for RS-232 or RS-422 remote communication. Connect a host computer or control system to this connector for serial control of the DVS by Simple Instruction Set (SIS) commands (see **Remote Configuration and Control**, beginning on page 48) or by the SPPCP software (see the control program help file).

The default protocol for this port is 9600 baud, 1 stop bit, no parity, and no flow control. Figure 8 shows the pin assignments for the DB-9 connector.

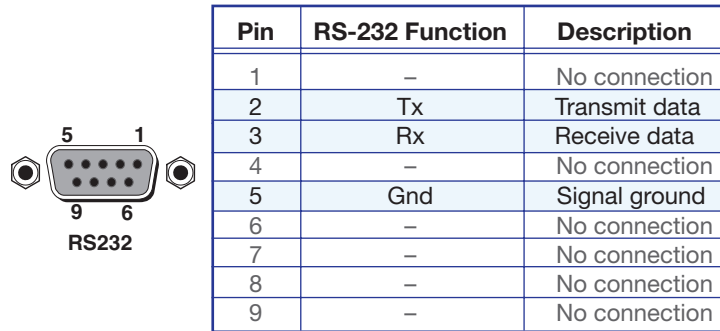

Figure 8. Pin Assignments for the RS-232 Port

Connecting to the RS-232 CONFIG Port (Front Panel)

The CONFIG port on the front panel is an additional RS-232 connector. A host device can be connected to this 2.5 mm TRS connector for serial RS-232 control, as an alternative to the rear panel RS232 port.

An optional 2.5 mm cable (part number 70-335-01) can be used to connect the DVS to a computer. Figure 9 shows the pin assignments for this cable.

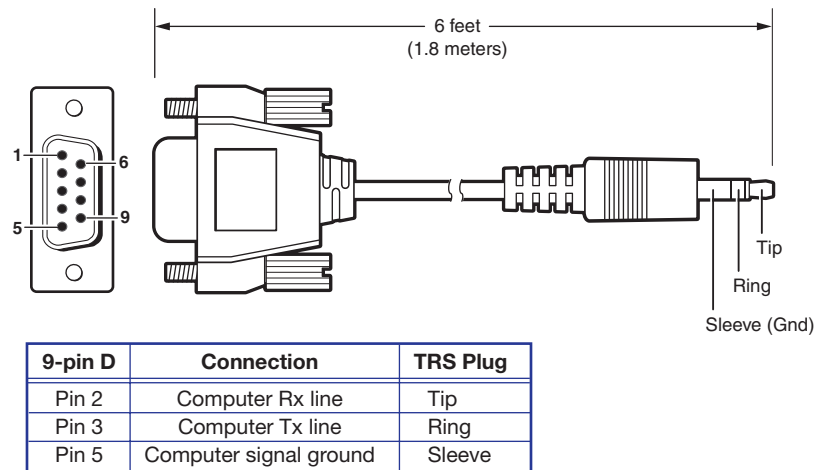

Figure 9. Optional 2.5 mm Connector Cable for the Configuration Port

(See **H CONFIG port** on page 16 for more information on this connector.)

Wiring the Amplified Audio Port (DVS 510 SA Only)

To connect speakers to the DVS 510 SA built-in amplifier, terminate the speaker cable as follows:

1. Strip the end of the cable 3/16 inches (5 mm).

ATTENTION:

- The length of the exposed wires in the stripping process is critical. The ideal length is 3/16 inches (5 mm). If the exposed portion is longer, the wires may touch, causing a short circuit between them. If the exposed wires are shorter, they can be easily pulled out, even if tightly fastened by the captive screws.
- Do not tin the wires. Tinned wires are not as secure in the captive screw terminals and could pull out.
- La longueur des câbles exposés est **primordiale** lorsque l'on entreprend de les dénuder. La longueur idéale est de 5 mm (3/16 inches). S'ils sont trop courts, ils peuvent être tirés facilement, même s'ils sont correctement serrés par les borniers à vis. S'ils sont trop longs, les câbles exposés pourraient se toucher et provoquer un court-circuit.
- Ne pas étamer les câbles. Les câbles étamés ne sont pas aussi bien fixés dans les terminaisons des à vis captives et pourraient sortir.

2. Secure the wires into the supplied 4-pole captive screw connector.

ATTENTION:

- Do not short the + and - outputs to each other because this will damage the amplifier.
- Ne pas créer un court-circuit entre les sorties + et - au risque d'endommager l'amplificateur.

The following table shows which speaker wires to connect to the positive and negative pins of the Amplified output connector.

Speaker Wire Color	To Amplified Connector Pins (Left and Right)
Red	Positive (+)
Black	Negative (-)

See [figure 10](#) on the next page for wiring instructions.

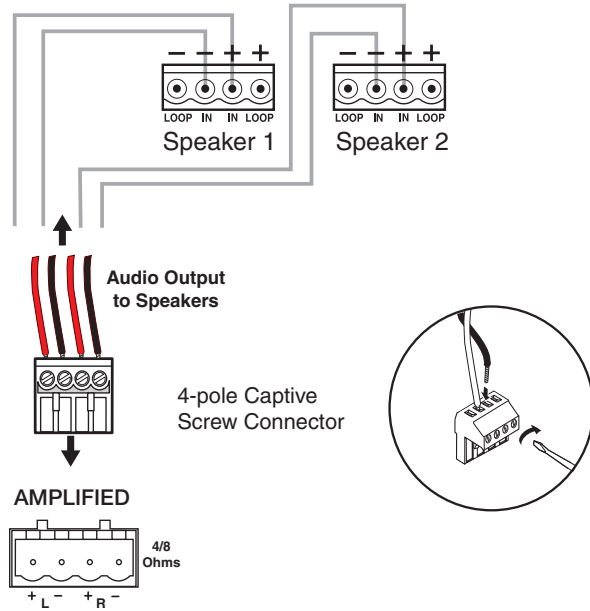

Figure 10. Wiring Speakers to the Amplified Connector on the DVS 510 SA

NOTE: Be sure to observe the correct speaker impedance loading when setting up a speaker system (see figure 10 for examples).

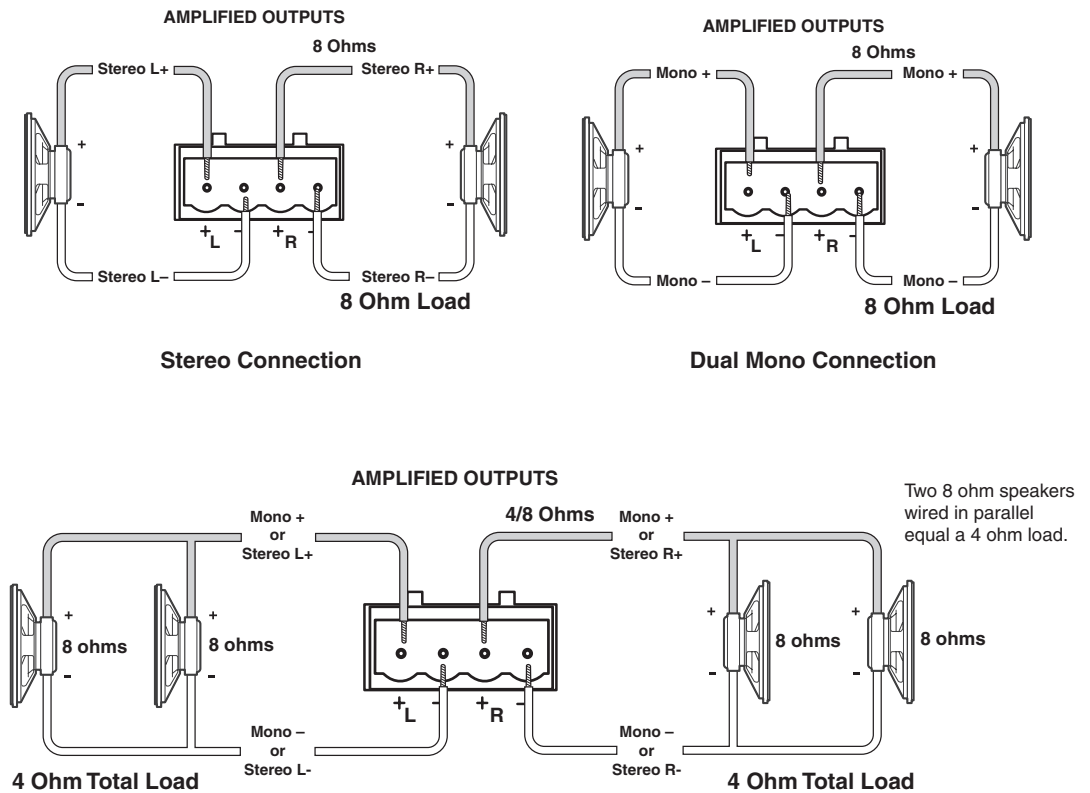

Figure 11. Speaker Connection Examples

Operation

This section discusses the functions available through the front panel to set up and operate the DVS 510 or DVS 510 SA. Topics include:

- **Front Panel**
- **Powering On**
- **Picture-in-Picture (PIP) Mode**
- **Menus on the LCD Screen**
- **Picture Controls**
- **Input Presets**
- **Audio Functions**
- **Resetting**
- **Front Panel Lockout (Executive Modes)**
- **Additional Features**
- **Using the Optional IR 904 Remote Control**

Front Panel

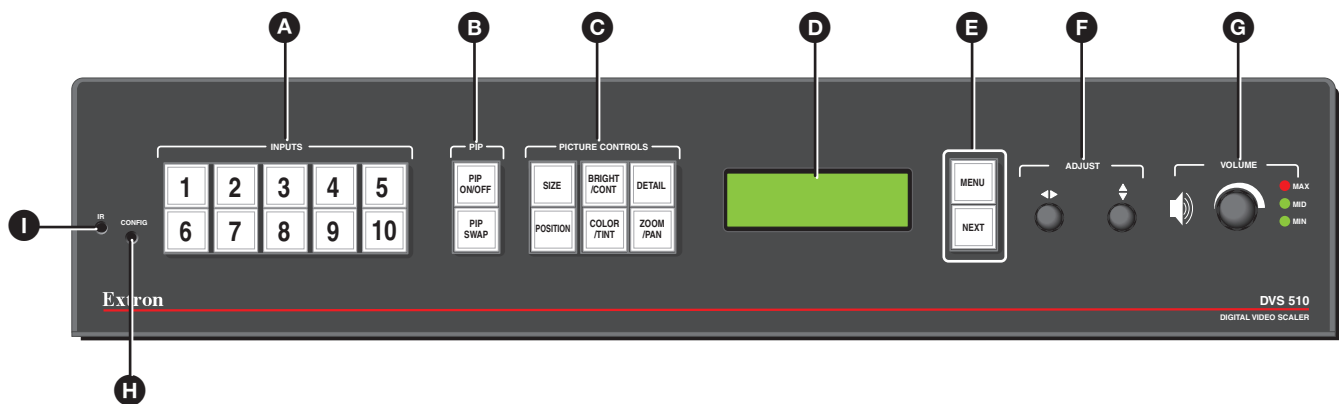

- **A Input buttons**
- **B PIP control buttons**
- **C Picture control buttons**
- **D LCD screen**
- **E Menu navigation buttons**
- **F ADJUST knobs**
- **G VOLUME knob and indicator LEDs**
- **H CONFIG Port**
- **I Infrared Sensor**

Figure 12. DVS 510 and DVS 510 SA Front Panel

The front panel features and controls shown in the illustration above are described starting on the [next page](#).

- A Input buttons** — Press the desired input button to select an input and switch it to the current output. The visual effect accompanying the switch (switch effect) can be a cut or a fade, depending on the selection (see **Advanced Configuration Menu** on page 29). With front panel input selection, audio always follows (switches with) the front panel video selection.

Video and audio breakaway switching are available only via SIS commands (see **Remote Configuration and Control**, beginning on page 48).

- **Signal types** — The input buttons listed below select connected sources that support the following signal types:
- **1 and 2** — Composite
- **3 and 4** — S-video
- **5, 6, 7, and 9** — RGB (includes RGBHV, RGBS, RGBcvs, and RGSB) or component video (YUVp/HDTV or YUVi)
- **8 and 10** — DVI
- **Input button lighting** — When an input button is pressed, it lights amber unless the DVS is in picture-in-picture (PIP) mode (see **Picture-in-Picture (PIP) Mode** on page 18 for more information). If the audio is broken away (switched separately from the video), the button for the selected video input lights green and the button for the selected audio input lights red.
- **Auto-Image** — If an input button is held for 3 seconds, the Auto-Image feature is activated for that input, sizing and centering the selected image to fill the screen (see **Auto Image submenu** on page 30).
- **Input buttons in PIP mode** — If the picture-in-picture (PIP) feature is enabled, the input buttons select an input for either the background (primary) window or the PIP (secondary) window. The primary input button lights amber and the secondary (PIP) input button lights green. If the PIP feature is turned off, the input buttons select the main output only, and no input button lights green.

If the PIP feature is on when an input is selected, the audio associated with that input in the PIP window is muted. The audio does not become unmuted until either:

- It is swapped to the main window.
- An SIS **Audio Follow** command has been issued to configure the DVS to make the audio follow the PIP window.

(See **Picture-in-Picture (PIP) Mode** for more information.)

- B PIP control buttons** — When PIP is enabled, a secondary image from a second source appears on the screen in front of the main image, in a previously selected size and position. The default size of the PIP window is one-fourth screen and it is positioned in the lower-right corner of the display.

The following two buttons control the picture-in-picture (PIP) function:

- **PIP On/Off button** — Turns PIP mode on and off (toggles between showing and hiding the picture-in-picture on the display). This button lights when the DVS is in PIP mode.
- **PIP Swap button** — Toggles the primary (main or background) and secondary (PIP) pictures between the main image and the PIP window.

(See **Picture-in-Picture (PIP) Mode** for more information on the picture-in-picture function.)

- C Picture control buttons** — Press these buttons to adjust window and image size, position, brightness, range of dark and light values (contrast), color, tint, detail, zoom (magnify or reduce), and pan. When one of these buttons is pressed, it lights amber.

NOTE: When PIP mode is enabled, all picture control adjustments affect only the PIP window.

(See **Picture Controls** on page 37 for details on these button functions.)

- D LCD screen** — Displays messages, menu information, and your selections from menus or control buttons (see **Menus on the LCD Screen** on page 20 for more information).
- E Menu navigation buttons** — Press **MENU** to access the DVS menu system and step through the menus. From each menu, press **NEXT** to step through the submenu (see **Menus on the LCD Screen** for details).
- F ADJUST knobs** — Rotate these horizontal (◀▶) and vertical (⬆⬇) knobs to scroll through submenu and picture control options and make adjustments.
- G VOLUME knob and indicator LEDs** — Turn this knob to adjust the volume on the input that is currently selected. The three LEDs, labeled Min, Mid, and Max, light incrementally in bottom to top order to indicate the current volume level. The Max LED (top) is red, and the others are green (see **Volume Control** on page 40 for details on these controls).
- H CONFIG port** — This configuration port on a 2.5 mm TRS connector is an alternative to the RS232 port on the DVS rear panel. (For a description of the rear panel RS232 port, see **Rear Panel** on page 7).

NOTE: This port supports RS-232 communication only. Only the rear panel RS232 port supports both RS-232 and RS-422.

Both of the DVS serial ports can be used for system configuration and control. Instructions are received through these ports from the computer via SIS commands or the Signal Processing Products Control Program. Both serial ports can be active at the same time.

The default protocol for this configuration port is:

- 9600 baud
- 8 data bits
- 1 stop bit
- No parity
- No flow control

An optional 2.5 mm TRS configuration cable is available at www.extron.com and can be used to connect your computer to this port (see **Connecting to the RS-232 CONFIG Port (Front Panel)** on page 11 for the configuration and pin assignments for this cable).

- I Infrared sensor** — This sensor receives infrared (IR) signals from the IR 904 remote control (see **Using the Optional IR 904 Remote Control** on page 44 for details).

Powering On

Apply power to the DVS by connecting the provided IEC power cord from the rear panel power connector to an AC power source. The scaler performs a self-test during which all the front panel buttons blink red, then green, then amber. At the same time, the initial two power-up screens are displayed on the LCD screen. At the completion of the self-test, all button lights turn off except for the previously selected Input button (Input 1 by default) and the **MENU** and **NEXT** buttons, all of which continue to be lit amber. If picture-in-picture (PIP) mode was enabled previously, the input button for the PIP source and the **PIP On/Off** button light green. The LCD panel displays the default cycle.

If an error occurs during the self-test, the DVS locks up and does not operate. If this occurs, call the Extron S3 Sales & Technical Support Hotline (see the [rear cover](#) for contact information in your area).

When power is first applied to the DVS, the LCD panel displays **Initializing Please Wait...**, then **Extron, DVS 510 Vn.nn**, where *nn* is the current firmware version. If the DVS self-test completes successfully, the default cycle begins, in which the LCD panel display alternates between the current output resolution and refresh rates, and the currently selected input number, signal type, and horizontal and vertical frequencies. These two screens continue to cycle on the screen when the menu system is not in use.

The flow diagram below shows the order in which the screens appear at power-up and in the default cycle.

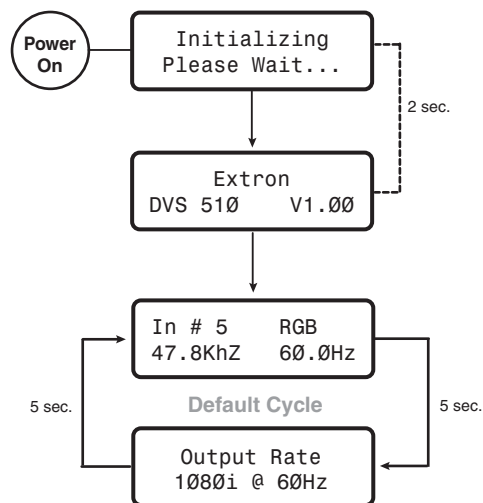

Figure 13. Power-up and Default Cycle

NOTE: Audio and video mute settings are not retained when power is cycled to the DVS.

Picture-in-Picture (PIP) Mode

The picture-in-picture (PIP) feature lets the DVS display two image sources on the screen simultaneously.

One of these image sources must be low-resolution (composite, S-video, YUVi, or RGBcvS) video, while the other must be high resolution (YUVp/HDTV, RGB, or DVI) video.

- **High resolution** — Inputs 5 through 7 and 9 if they are configured as RGB (RGBHV, RGBS or RGsB) or high-resolution component video YUVp/HDTV; inputs 8 and 10 (DVI).
- **Low resolution** — Inputs 1 through 4, and 5 through 9 when they are configured as component video YUVi or RGBcvS

The PIP function toggles between the selected input in each resolution group. The PIP function **cannot** toggle between two inputs in the same resolution group.

The following table shows the resolution of each input:

Input	High Resolution	Low Resolution
1		Composite
2		Composite
3		S-video
4		S-video
5	RGB, YUVp/HDTV	YUVi, RGBcvS
6	RGB, YUVp/HDTV	YUVi, RGBcvS
7	RGB, YUVp/HDTV	YUVi, RGBcvS
8	DVI (all formats)	
9	RGB, YUVp/HDTV	YUVi, RGBcvS
10	DVI (all formats)	

By default, the PIP image is one-fourth the size of the main window and is positioned in the lower-right corner of the display.

NOTE: The size of the PIP window can be set in the menu system (see [Enabling PIP Mode](#) on the next page). The position of the PIP window is set with the centering adjustment (see [Picture Controls](#) on page 37 for details).

When PIP mode is active:

- The button for the main window input lights amber. The PIP input button lights green.
- All picture controls configure only the image in the PIP window. The main window settings cannot be modified while the PIP window is active. The PIP size and position can be adjusted with the same front panel controls or SIS commands used to adjust the main image.
- The parameters of the PIP window are adjustable from the front panel menus or by SIS commands only.
- Any change in configuration (except sizing or positioning) of the PIP window is saved to that input even after the PIP mode is no longer active.
- The PIP window input is shown in the default cycle as the current input.
- If the PIP window source is not active, the PIP mode exits until an active signal is detected. When the main window source is removed, a black background is displayed.
- Audio and video breakaway are not allowed.

Enabling PIP Mode

To enable picture-in-picture mode:

1. **Select an input** for the main window. The selected input button lights amber.
2. Configure the input for the main window as desired (see [Input Configuration Menu](#) on page 23 and [Picture Controls](#) on page 37).
3. Press the **PIP ON/OFF** button to activate the PIP mode.
 - The input button for the PIP window lights green.

NOTE: The first time the DVS is placed in PIP mode, by default input 1 is selected if the main input is high resolution, and input 5 is selected if the main input is low resolution. If PIP mode has been enabled previously, the input in the correct resolution category that was the PIP input most recently is selected.

- The PIP window appears on the screen in its previously displayed size and position. (On first activation, the PIP window appears in the default size and position.)

Configure the PIP window as desired, using the same methods you used to configure the main window in step 2.

You can also enable PIP via SIS commands (see the [Picture-in-picture \(PIP\) commands](#) on page 62 in the Command and Response Table for DVS 510 SIS Commands), the Windows-based control software (see the SPPCP help file), the web pages (see [PIP Setup Page](#) on page 106), or using the IR remote control (see [Using the Optional IR 904 Remote Control](#) on page 44).

Changing the PIP Input

To change the input for the PIP window or the main window, determine if the corresponding input is low- or high-resolution.

If your main window image is from a low-resolution source, switch to another low-resolution input from the front panel.

NOTE: The front panel buttons do not permit you to select two low-resolution or two high-resolution inputs. For example, if you have selected input 1 (composite) for the main window (the button is lit amber) and then you press the button for input 2 (also composite), input 2 is selected for the main window (lights amber) and input 1 is deselected.

Using the PIP Swap Feature

Use the swap feature to switch the active main window input with the current PIP input. For example, if the main window is input 5 (RGB scaled) and the PIP window is input 1 (composite), applying the swap command results in input 1 becoming the main window and input 5 the PIP window.

To swap the main window input with the PIP input, press the **PIP SWAP** button. The buttons switch colors from amber to green and vice versa.

You can set audio to follow the main (default) window or the PIP window. Audio breakaway is not possible while PIP mode is on. Audio must follow either the main window or the PIP window.

Menus on the LCD Screen

The DVS 510 menus that are displayed on the LCD screen enable you to configure and operate the scaler. The menu navigation buttons (**MENU** and **NEXT**) are located to the right of the LCD screen. Press these buttons to cycle through the available menus and submenus, and use the horizontal and vertical **ADJUST** knobs to select options.

This section describes the options on these menus and their submenus, including any procedures that are initiated from them.

Menu System Overview

The menu system consists of six menus, some of which have submenus that enable you to make desired adjustments (see the [menu flow diagram](#) on the next page).

Using the menus

1. To access the menu system, press the **MENU** button. The first menu name (**User Presets**) is displayed on the LCD screen.
2. Select other menus by repeatedly pressing the **MENU** button until the desired menu name is displayed.
3. When the desired menu appears on the LCD screen, press the **NEXT** button repeatedly to cycle through the submenus for the selected menu.
4. When the desired submenu is displayed, rotate the horizontal (**◀▶**) or vertical (**⬆⬇**) **ADJUST** knob clockwise or counterclockwise to cycle through the submenu options. If you want to return to a menu from within one of its submenus, press **MENU**.
5. When the desired option is displayed, do one of the following to select it:
 - Press **NEXT** to display another submenu.
 - Press **MENU** repeatedly until the Exit MENU? Press NEXT screen appears, then press **NEXT** to return to the default cycle.
 - Do nothing more, and wait until the LCD screen returns to the default cycle (approximately 30 seconds).

NOTE: The menu time out and the default cycle is displayed after 30 seconds of inactivity. However, any selections you made with the **ADJUST** knobs are saved and remain in effect until you change them or reset the unit to factory defaults (see [Resetting](#) on page 41).

Menu flow diagram

The flow diagram below shows the menus that are displayed in the front panel LCD window and the order in which they appear when you repeatedly press the **MENU** button.

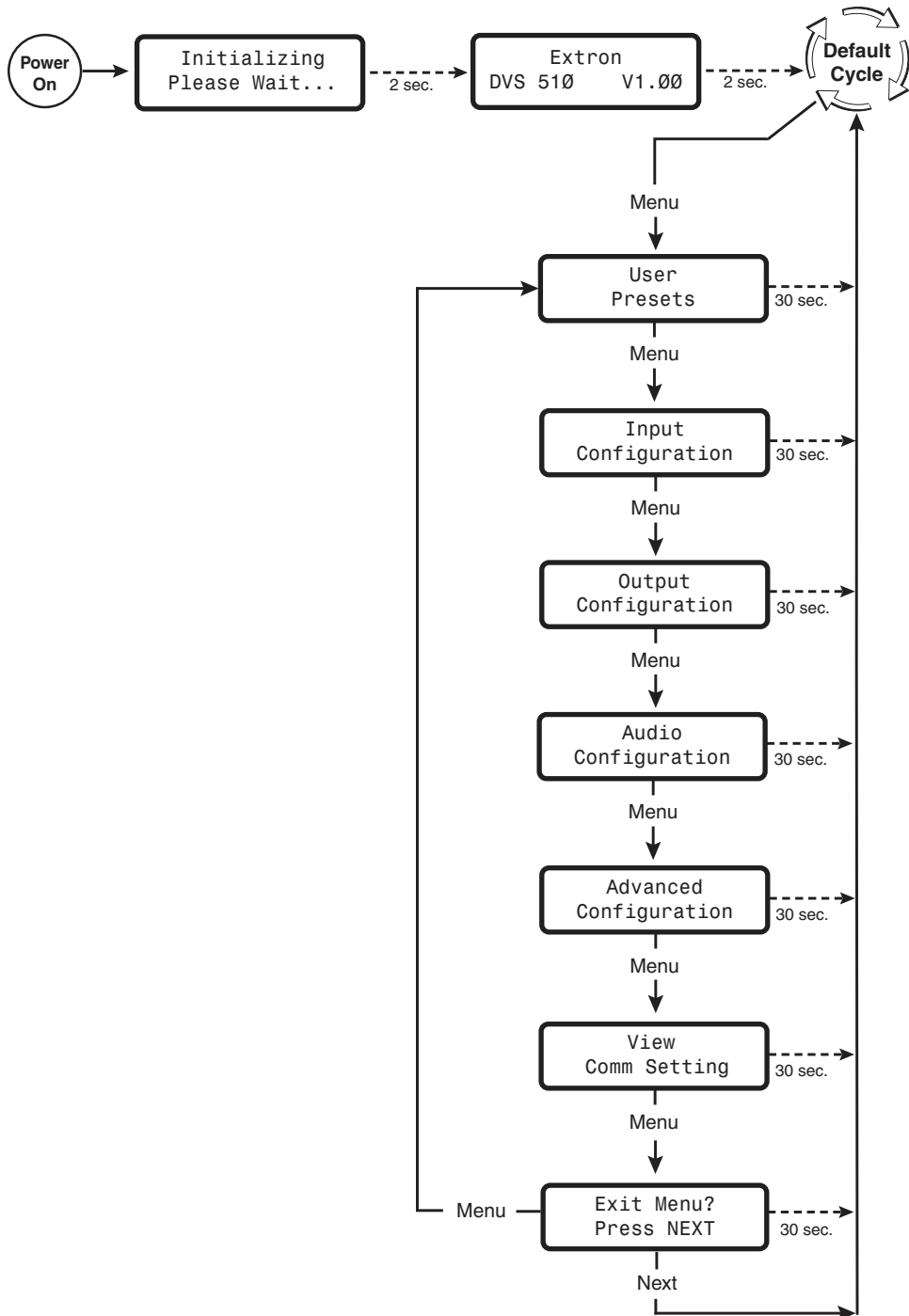

Figure 14. Main Menu

The following sections describe the submenu options for each of the menus.

User Presets Menu

User presets save the current set of image parameters for the selected input. Each input has 16 available user memory presets to which you can save settings or recall using this menu, an SIS command (see the **User Presets commands** on page 64) or the **Presets Web page** (see **Memory/Input Presets Page** on page 104).

The following settings are saved in a user preset:

- Color
- Tint
- Contrast
- Brightness
- DETAIL
- Horizontal position
- Vertical position
- Horizontal size
- Vertical size
- Pan
- Zoom

Saved user presets can be recalled to be applied to the current input.

The following flowchart provides an overview of the **User Preset** submenus and the options for each setting.

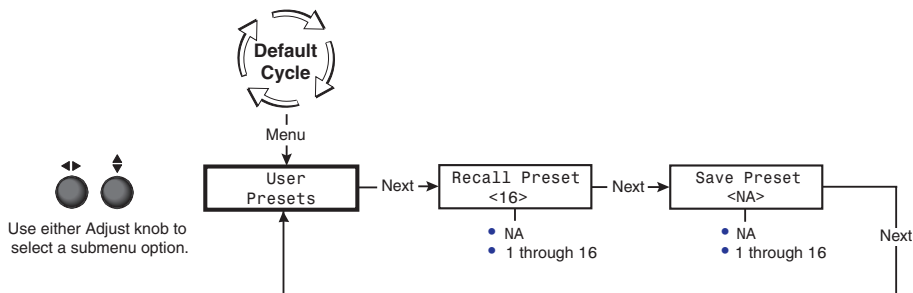

Figure 15. User Presets Menu

Saving or recalling a user preset

1. Press the **MENU** button until **User Presets** is displayed in the LCD window.
2. Press the **NEXT** button until the desired submenu name is displayed: **Recall Preset** or **Save Preset**.
3. Rotate either **ADJUST** knob until the LCD screen displays the number of the preset to which you want to save the current settings, or that you want to recall.
4. Press **NEXT** to save or recall the preset. The **User Presets** menu is displayed.
5. To exit the user presets function without saving a preset, press **MENU**.

NOTES:

- The presets are saved in nonvolatile memory, therefore, powering down the DVS does not lose the presets.
- User presets can be saved at one input resolution and rate and recalled to a different one.

Example: If the current output resolution is 1024x768 and a 720p input is applied, you can size and center a “letterbox” image for a 16:9 input resolution and save it to a user preset. Subsequently, if a 1080p resolution is applied to the unit, the letterbox preset that was saved at 720p can be recalled with the new 1080p input resolution.

Input Configuration Menu

The **Input Configuration** menu allows you to select a video signal type for the configurable inputs: 5, 6, 7, and 9. (Inputs 1 and 2 are composite video only, inputs 3 and 4 are S-video only, and inputs 8 and 10 are DVI only.) The table below summarizes the available signal types for each input.

Input 1	Input 2	Input 3	Input 4	Input 5	Input 6	Input 7	Input 8	Input 9	Input 10
Composite	Composite	S-video	S-video	RGB*	RGB*	RGB*	DVI	RGB*	DVI
				YUVp/ HDTV	YUVp/ HDTV	YUVp/ HDTV		YUVp/ HDTV	
				RGBcvs	RGBcvs	RGBcvs		RGBcvs	
				YUVi	YUVi	YUVi		YUVi	

*Default

You can also enable and disable film detection, select the horizontal and vertical start positions, pixel sampling phase, total pixels, active pixels, active lines, and select an EDID (extended display identification data) for an input. Rotate the horizontal (◀▶) or the vertical (⬆⬇) **ADJUST** knob to adjust the settings.

The following flowchart provides an overview of the **Input Configuration** menu and submenus and the options for each setting.

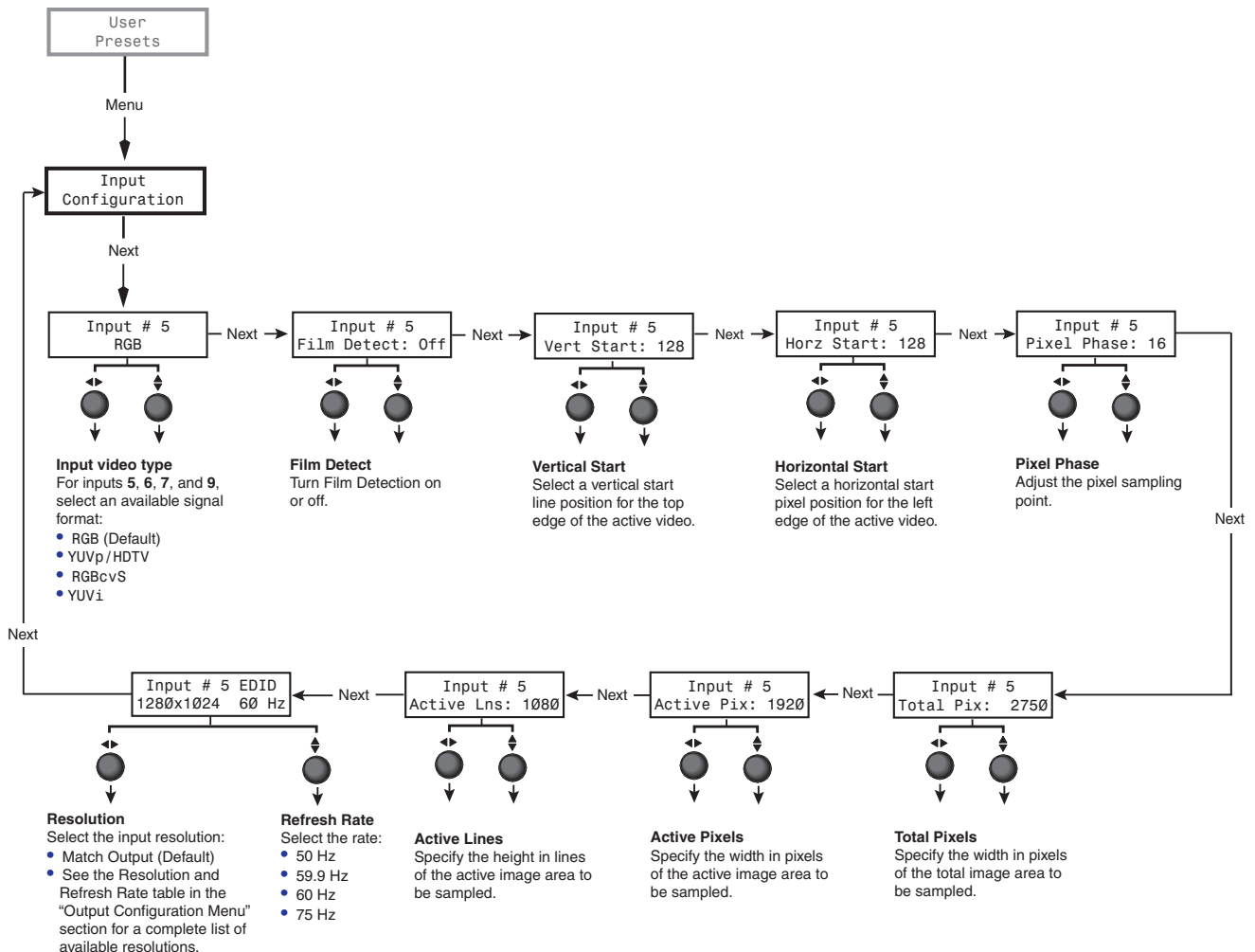

Figure 16. Input Configuration Menu

Selecting an input

To select an input, press the numbered input button. The button lights amber. The selected input number is displayed in the LCD window on the first screen of the default cycle. Inputs can also be selected via an SIS command, the SPPCP software, the web pages, and the IR 904 remote control.

In #5	RGB
47.8kHz	60.0Hz

Configuring an input

Follow these steps to configure any of the 10 video inputs:

1. Press the numbered button for the input to configure.
2. Press the **MENU** button until **Input Configuration** is displayed in the LCD window (see [figure 16](#) on the previous page).
3. Press the **NEXT** button repeatedly until the desired input parameter submenu is displayed.
4. Rotate either **ADJUST** knob until the desired submenu option is displayed.

NOTE: For EDID settings, rotate the horizontal knob (◀▶) to adjust the resolution and the vertical **ADJUST** knob (⬆) to select a refresh rate (inputs 5, 6, 8, and 10 only).

5. To save the input configuration, press **MENU** once or **NEXT** repeatedly to return to the top level menu.

Alternatively, wait for the LCD display to time out and return to the default cycle (approximately 30 seconds). The DVS saves the new settings.

NOTE: Depending on the signal type of the selected input, different adjustments are available for the different inputs (see the table below).

Available input adjustments

The following table shows which adjustments are available for each input type.

	Composite (Inputs 1 and 2)	S-video (Inputs 3 and 4)	RGB (Inputs 5, 6, 7, and 9)	YUVp/HDTV (Inputs 5, 6, 7, and 9)	RGBcvS (Inputs 5, 6, 7, and 9)	YUVi (Inputs 5, 6, 7, and 9)	DVI (Inputs 8 and 10)
Film Detect	X	X	X	X	X	X	X
Vert. Start			X	X			
Horiz. Start			X	X			
Pixel Phase			X	X			
Total Pixels			X	X			
Active Pixels	X	X	X	X	X	X	X
Active Lines	X	X	X	X	X	X	X
EDID			X (Inputs 5 and 6 only)				X

Input configuration submenu adjustments

The following table shows how to make the selections and adjustments that are accessed through the **Input Configuration** submenus.

Input Configuration Submenu	Horizontal (◀▶) and Vertical Knob (↕) Adjustment
<p>Video Signal Type (Inputs 5, 6, 7, and 9) Accepted video signal types include RGB, RGBcvS, YUVp/HDTV, and YUVi.</p>	<p>Select the desired video format for the selected input. The default is RGB.</p>
<p>Film Mode Detect Enable and disable 3:2 pulldown detection for NTSC and 2:2 film detection for PAL video sources. 3:2 and 2:2 pulldown (film modes) help maximize image detail and sharpness for video sources that originated from film. When film is converted to NTSC video, the film frame rate must be matched to the video frame rate. “Jaggies” and other image artifacts can result if conventional deinterlacing techniques are used on film-source video. When film mode is enabled, the DVS recognizes signals that originated from film and then applies video processing algorithms that optimize the conversion of video that was made with the 3:2 or 2:2 pulldown process. This results in sharply detailed images.</p>	<p>Select On or Off to turn 3:2 or 2:2 pulldown (film mode) detection on and off for the selected input. The default is Off.</p>
<p>Vertical Start Position The distance in pixels from the top edge of the total video display area for the selected input to the top edge of its active area</p>	<p>Select the vertical start position. The default is 128.</p>
<p>Horizontal Start Position The distance in pixels from the left edge of the total video display area for the selected input to the left edge of its active area</p>	<p>Select the horizontal start position. The default is 128.</p>
<p>Pixel Phase (Inputs 5, 6, 7, and 9) The point at which pixels are sampled (available only for RGB and YUVp/HDTV inputs)</p>	<p>Select the amount to move the pixel sampling point to ensure output clarity. The range of settings is 0 through 31. The default is 16.</p>
<p>Total Pixels (Inputs 5, 6, 7, and 9) The width in pixels of the total video display area (available only for RGB and YUVp/HDTV inputs)</p>	<p>Select the width in pixels of the total video display area for the selected input. The default width is marked with an asterisk (*) on the LCD screen.</p>
<p>Active Pixels The width in pixels of the active video area</p>	<p>Select the width in pixels of the active video area for the selected input. The default width is marked with an asterisk (*) on the LCD screen.</p>
<p>Active Lines The height in lines of the active video area</p>	<p>Select the height in lines of the active video area of the selected input. The default width is marked with an asterisk (*) on the LCD screen.</p>

Input Configuration Submenu	Horizontal (◀▶) and Vertical Knob (⬆⬇) Adjustment
<p>EDID (Extended Display Identification Data) (Inputs 5, 6, 8, and 10)</p> <p>The resolution and refresh rate of a display device (available only for RGB and DVI inputs)</p> <p>NOTE: This submenu is not displayed when input 1-4, 7, or 9 is selected.</p>	<p>Select an EDID to apply to the selected input.</p> <ul style="list-style-type: none"> The horizontal (◀▶) ADJUST knob selects the resolution. The vertical (⬆⬇) ADJUST knob selects the refresh rate.

Output Configuration Menu

The output configuration menu allows you to set output resolution and refresh rate, output signal type, and sync polarity (RGBHV only). The following flow diagram shows the output configuration submenus and the adjustments that can be made from them.

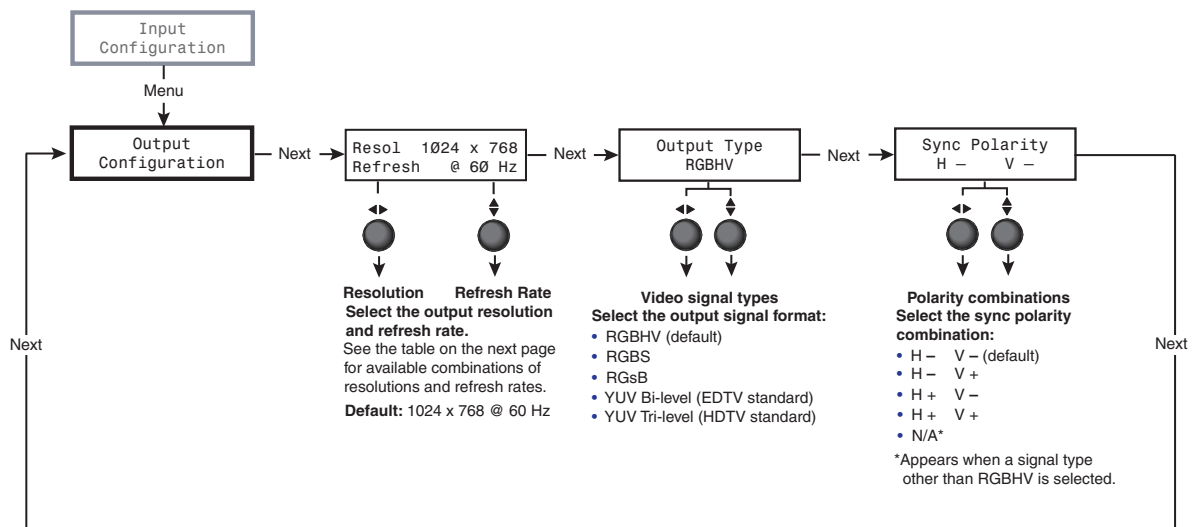

Figure 17. Output Configuration Menu

Resolutions and refresh rates submenu

While the **Output Configuration** menu is displayed, rotate the horizontal **Adjust** (◀▶) knob to select the output resolution and the vertical **Adjust** (⬆⬇) knob to select the refresh rate. The default resolution and rate for the DVS 510 Series are 1024x768 @ 60 Hz.

The [table on the next page](#) shows the available resolutions and refresh rates on the DVS 510 Series.

Resolution	23.98 Hz	24 Hz	25 Hz	29.97 Hz	30 Hz	50 Hz	59.94 Hz	60 Hz	75 Hz
640 x 480						X		X	X
800 x 600						X		X	X
852 x 480						X		X	X
1024 x 768*						X		X*	X
1024 x 852						X		X	X
1024 x 1024						X		X	X
1280 x 768						X		X	X
1280 x 800						X		X	X
1280 x 1024						X		X	X
1360 x 765						X		X	X
1360 x 768						X		X	X
1365 x 768						X		X	X
1366 x 768						X		X	X
1365 x 1024						X		X	X
1440 x 900						X		X	X
1400 x 1050						X		X	
1680 x 1050						X		X	
1600 x 1200						X		X	
1920 x 1200						X		X	
480p			X	X			X	X	
576p						X			
720p			X	X	X	X	X	X	
1080i						X	X	X	
1080p	X	X	X	X	X	X	X	X	
2048 x 1080	X	X	X	X	X	X	X	X	

*Default resolution

NOTE: The default refresh rate of 60 Hz is applied when the DVS switches to a different resolution except for 576p, for which it defaults to 50 Hz.

Output Type submenu

Rotate either the horizontal (◀▶) or the vertical (⬆⬇) **ADJUST** knob to select the output video format required by the display. Available signal types are RGBHV (default), RGBS, RGB, YUV bi-level, and YUV tri-level.

Sync Polarity submenu

The display device may require a particular combination of horizontal (H) and vertical (V) sync signal polarities. Select the appropriate combination of positive or negative H and V sync by rotating either the horizontal (◀▶) or vertical (⬆⬇) **ADJUST** knob. Options are **H-V-** (default), **H+V-**, **H-V+**, or **H+V+**.

NOTE: This submenu applies only to RGBHV format. For all other output formats, N/A is displayed for this submenu.

Audio Configuration Menu

The **Audio Configuration** menu enables you to adjust the levels of gain, attenuation, bass, and treble, enable and disable the limiter for the amplifier (DVS 510 SA only), turn audio delay on and off, and select the audio output type (stereo or dual mono). The flow diagram below shows the **Audio Configuration** submenus and the adjustments that can be made from them.

NOTE: The volume of the Variable output can be adjusted via the DVS front panel **VOLUME** knob (see **Volume Control** on page 40), SIS commands (see the **Audio Volume commands** on page 63) or the Signal Processing Products Control Program (see the control program help file).

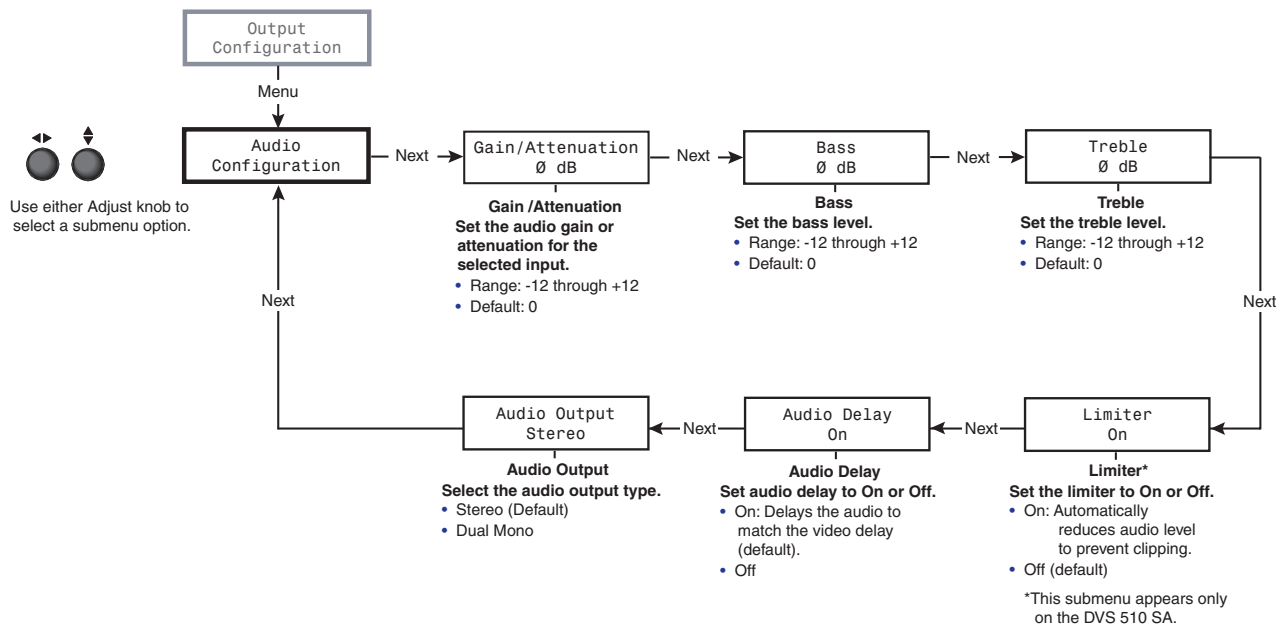

Figure 18. Audio Configuration Menu

Gain/Attenuation submenu

To set the gain and attenuation levels from this submenu, rotate either **ADJUST** knob to the right to select the gain (0 through +12) and to the left to select the attenuation (0 through -12). The default is 0.

Bass and Treble submenus

To increase or decrease the bass and treble levels:

1. Press **NEXT** until the desired submenu (**Bass** or **Treble**) is displayed.
2. Rotate either the **ADJUST** knob right to increase or left to decrease the level of bass or treble.

The range for bass and treble is -12 through +12. The default is 0.

Limiter submenu (DVS 510 SA only)

The **Limiter** submenu is displayed only on the DVS 510 SA. When enabled, the limiter reduces the amplifier level to prevent clipping. To enable the limiter, rotate either **ADJUST** knob to the right until the LCD screen displays **On**. To disable the limiter, rotate either knob to the left until **Off** is displayed. The default is **Off**.

Audio Delay submenu

This submenu lets you delay the audio to match the video delay. To enable audio delay, rotate either **ADJUST** knob to the right until the LCD screen displays **On**. To disable audio delay, rotate either knob to the left until **Off** is displayed. The default is **On**.

Audio Output submenu

From this submenu you can select stereo or dual mono for the audio output type.

- **In stereo mode**, the audio signal from the left channel is output to one speaker while the signal from the right channel is output to the other speaker.
- **In dual mono mode**, the inputs from the left and right channels are summed together and are output to the speakers together as two mono channels, so that the left and right outputs contain the same combined signal information.

To select the audio type, rotate either adjust knob right to select **Stereo** or left to select **Dual Mono**. The default is **Stereo**.

Advanced Configuration Menu

Use the **Advanced Configuration** menu to enable auto-imaging for one or more selected inputs, enable or disable auto memories, select the aspect ratio for the current input, set the amount of seconds for RGB delay, select a switch effect, select a test pattern, view the DVS internal temperature, and initiate a reset of the scaler to factory defaults.

Figure 19 shows a flow diagram of the **Advanced Configuration** menu and submenus and the adjustments that are available from them.

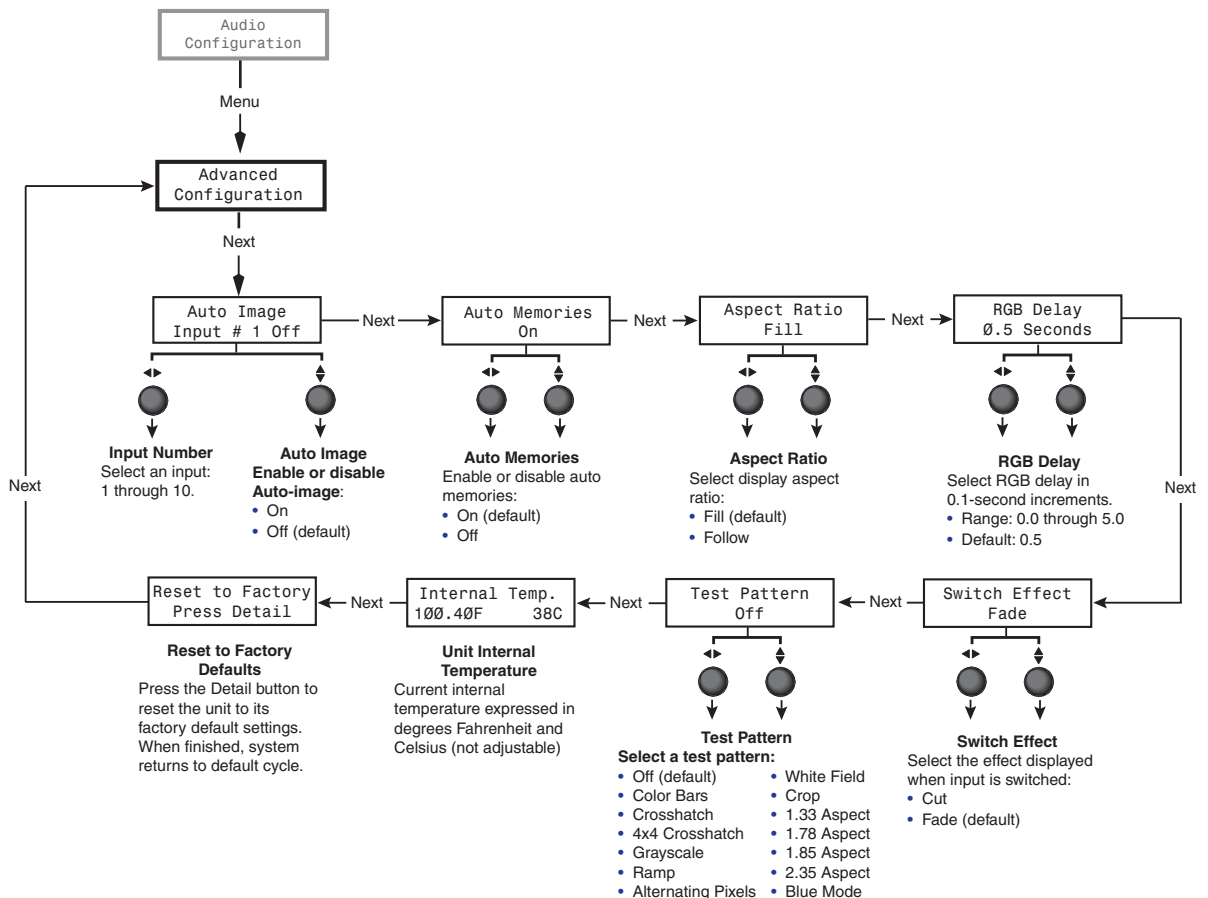

Figure 19. Advanced Configuration Menu

Auto Image submenu

Auto-Image is enabled per input. When an input is connected and Auto-Image is enabled, the DVS performs an image adjustment in which it measures where the active area starts and stops, then adjusts input sampling accordingly, so that the image fills the window. The scaler measures the sync frequencies of the incoming video source and sets the active image area, total image area, and the sampling frequency according to a table stored on the DVS. If an unknown input is connected to the DVS, the scaler measures and estimates the resolution of the incoming video. If the estimate proves inaccurate, the Auto-Image function makes measurements to more accurately set up the input sampling.

Auto-image affects the following settings:

- Active pixels
- Active lines
- Horizontal start
- Vertical start
- Pixel phase
- Horizontal position
- Vertical position
- Horizontal size
- Vertical size

All other settings are unchanged when an Auto-Image is performed.

If the aspect ratio is set to Fill, the horizontal and vertical position is set to 0,0, and the horizontal and vertical size is set to match the current output rate. If the aspect ratio is set to Follow, the horizontal and vertical position is set to maintain the native aspect ratio of the input with respect to the current output resolution.

If auto memories are enabled, the DVS first checks for an existing memory entry for the connected input (see “Auto Memories submenu”).

Auto-Image is useful in applications in which a variety of input sources are likely to be encountered, such as on a lectern or podium where guest laptops might be plugged in.

To enable or disable Auto-Image for an input:

1. From the **Advanced Configuration** menu, press **NEXT** until the **Auto Image** submenu is displayed.
2. Rotate the horizontal **ADJUST** knob (◀▶) to select the input to be auto-imaged.
3. Rotate the vertical **ADJUST** knob (⬆⬇) to select **On** or **Off** for Auto-Image.

The default input selection is input 1. The default Auto-Image status is **Off**.

Auto Memories submenu

When auto memories is activated, the DVS stores size, position, and picture settings based on the incoming signal from the connected input. When the same input signal is detected again, these image settings are recalled from memory.

To enable or disable auto memories:

1. Press **NEXT** until the **Auto Memories** submenu is displayed.
2. Rotate either **ADJUST** knob to the right to select **On** or to the left to select **Off**.

The default for auto memories is **On**. It is recommended that auto memories not be disabled unless you are using an input preset (selectable via SIS commands, the SPPCP, and the Web pages) or if you want each input to be treated as a new input without using saved settings.

NOTE: When an Auto-Image is performed, auto memory is checked first and if an entry is found, its settings are used. If you do not want to use the auto memories settings, disable auto memories before allowing Auto-Image to be performed (see the table below for the results of combinations of Auto-Image and auto memories settings.)

Auto Memories and Auto-Image Interaction		
Auto memories	Auto-Image	Action
On	On	New signals or rates that have not been previously detected by the DVS 510 are initially set up using default parameters, then Auto-Image is applied and the values are stored. The next time that signal is detected, the values stored in the auto memory location are applied.
On	Off	(Default) New signals or rates that have not been previously detected by the DVS 510 are set up using default parameters. If manual input or picture settings are made to the input, an auto memory location is created and recalled each successive time the input is detected.
Off	On	Each change in input sync triggers an automatic Auto-Image. When auto memory is disabled, each change in sync is treated as a new signal and an automatic Auto-Image is triggered. Any manual changes made to the image and picture controls are lost each time a new rate is detected.
Off	Off	Each change in input sync causes default values to be applied to the rate. Any manual changes made to the image and picture controls are lost when a new rate is applied.

Aspect Ratio submenu

The aspect ratio control allows you to select between **Fill** (the input signal at each rate fills the entire output raster), or **Follow** (the input signal at each rate is displayed with its native aspect ratio [default setting]).

- **In fill mode**, if you want an aspect ratio adjustment for a single input rate, you can set up the correct size and centering by using one of the Aspect Ratio test patterns as a template (see **Test Pattern submenu** on the next page). If auto memories is enabled, this setting is saved and recalled the next time the signal is detected.
- **In follow mode**, each input rate is displayed with its native aspect ratio (4:3, 5:4, 16:9, or 16:10). You can view the correct letterbox or pillar box settings by pressing the **SIZE** or the **POSITION** button. If a single input is to fill the entire raster in follow mode, you can manually set the position (center) to **0,0** and the size to match the current output rate (see **Picture Controls** on page 37).

To select the aspect ratio mode:

1. From the **Configuration** menu, press **NEXT** until the **Aspect Ratio** submenu is displayed.
2. Rotate either **ADJUST** knob to select the desired mode.

RGB Delay submenu

The RGB delay feature applies a brief delay before displaying a new input on a screen, allowing the display device to adjust to the new sync timing. This delay shows the viewers a blank screen, masking any glitch during switching. The **RGB Delay** options are **0** to **5** seconds in 0.1-second increments.

To set the RGB delay time:

1. From the **Advanced Configuration** menu, press **NEXT** until the **RGB Delay** submenu is displayed.
2. Rotate either **ADJUST** knob to select the amount of delay.

Switch Effect submenu

Two effects are available to be displayed on the output screen when the input is switched:

- **Cut** — The current input is immediately replaced with the image from the new input.
- **Fade** — The current input fades to black and the new input fades in (default).

To select a switch effect:

1. From the **Advanced Configuration** menu, press **NEXT** until the **Switch Effect** submenu is displayed.
2. Rotate either **ADJUST** knob to the right to select **Fade** or to the left to select **Cut**.

Test Pattern submenu

The following test pattern selections are available via this submenu to help you adjust the display device for color, convergence, focus, resolution, contrast, grayscale, and aspect ratio (see **figure 20** on the next page):

- Off (default)
- Color Bars
- Crosshatch
- 4x4 Crosshatch
- Grayscale
- Ramp
- Alternating Pixels
- White Field
- Crop
- 1.33 Aspect
- 1.78 Aspect
- 1.85 Aspect
- 2.35 Aspect
- Blue Mode

NOTE:

- **Alt Pixels** is used to calibrate display devices input sampling to the DVS output. Use this pattern to adjust the clocking and phasing at the display until no more vertical bands are visible.
- **Crop** is used to center the DVS output on the display device. Adjust the horizontal and vertical position on the display until all four crop lines are visible.
- **Color Bars** is used to calibrate color settings on the display and to confirm proper system wiring.
- **Blue Mode** causes only sync and blue video signals to pass to the display. This can assist you in setting up the color and tint levels of the video input.

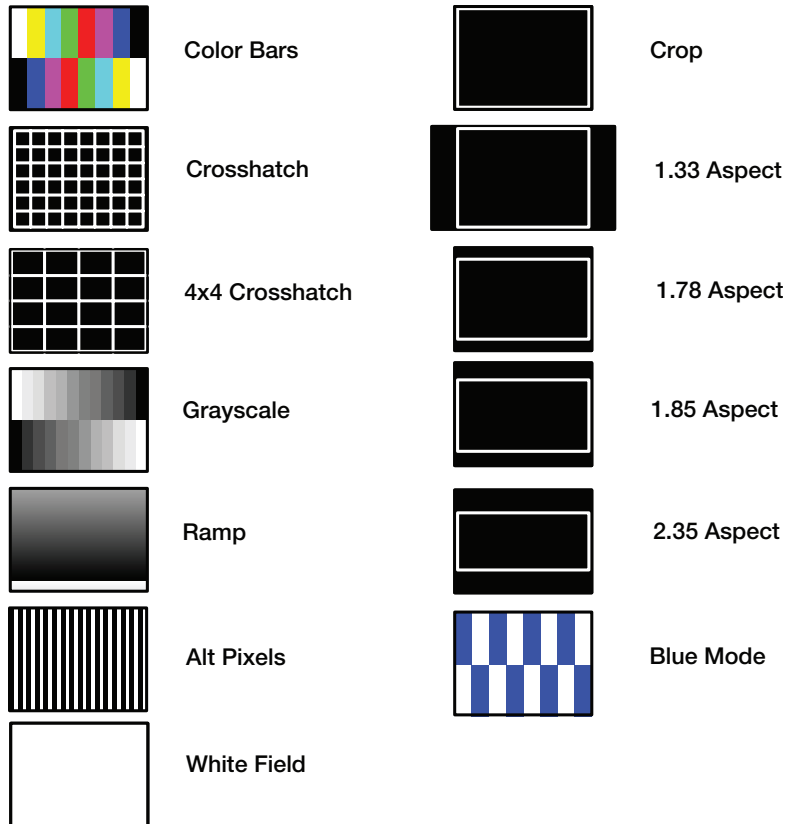

Figure 20. DVS 510 Series Test Patterns

To select a test pattern:

1. From the **Advanced Configuration** menu, press **NEXT** until the **Test Pattern** submenu is displayed.
2. Rotate either **ADJUST** knob to select a test pattern. The default is **Off** (no test pattern).

Internal Temp. screen

The **Internal Temp.** screen shows the current internal temperature of the DVS unit in degrees Fahrenheit and Celsius. This is an information-only screen and no adjustments can be made from it.

Reset to Factory screen

This screen lets you reset the DVS to the default settings with which it was delivered from the factory. To reset the unit:

1. From the **Advanced Configuration** menu, press **NEXT** until the **Reset to Factory Press DETAIL** screen is displayed. The **DETAIL** button under **Picture Controls** begins to blink.
2. To initiate the reset, press **DETAIL**. When the reset is complete, the default cycle is displayed.

View Comm Settings Menu

The **View Comm Settings** menu lets you view the current settings for the communication ports, including the IP, subnet mask, and gateway addresses of the unit, the MAC (Media Access Code or hardware) address, the Dynamic Host Configuration Protocol (DHCP) status, and the serial port baud rate and type.

NOTE: None of the settings can be changed from this menu; to make adjustments, use the **Edit Comm Settings** menu (see “Edit Comm Settings Menu”).

The flow diagram below shows the screens and the settings that can be viewed from this menu.

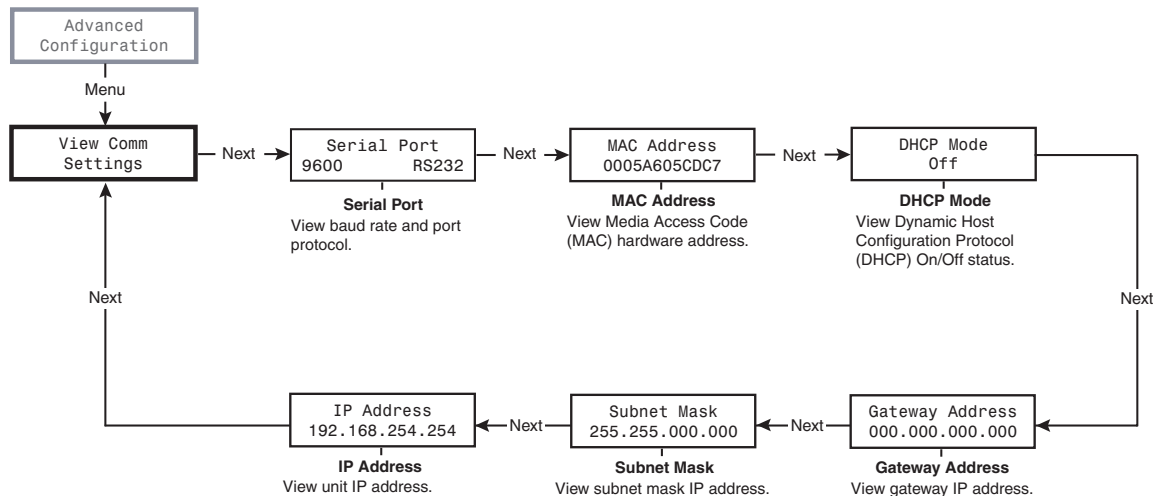

Figure 21. View Comm Settings Menu

Edit Comm Settings Menu

This menu (see [figure 22](#) on the next page) lets you make changes to the serial port configuration, IP addresses, and the DHCP mode. Although the **Edit Comm Settings** menu has almost all the same screens as the **View Comm Settings** menu, it is accessed differently.

NOTE: You can access the **Edit Comm Settings** menu from any other menu or from the default cycle.

To display the **Edit Comm Settings** menu:

1. Press and hold the **NEXT** button.
2. While holding the **NEXT** button, press the **DETAIL** and **COLOR/TINT** buttons simultaneously.
3. Hold all three buttons until the **Edit Comm Settings** screen is displayed (approximately 2 seconds).

If no activity occurs within 30 seconds, the DVS saves all settings and returns to the default cycle.

Figure 22 shows the **Edit Comm Settings** screens and the adjustments that are available from them.

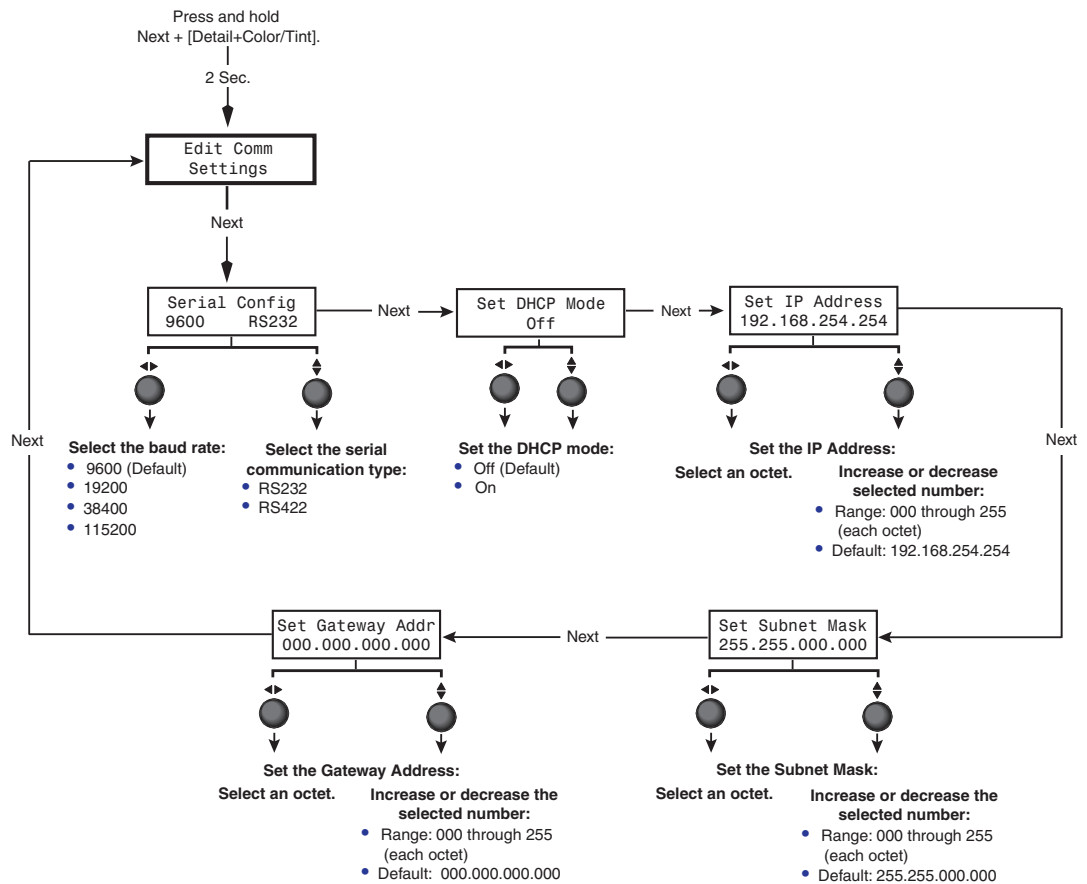

Figure 22. Edit Comm Settings Menu

Adjustments can be made via the following **Edit Comm Settings** screens:

Serial Configuration submenu

1. Press **NEXT** until the **Serial Configuration** screen is displayed.
2. Rotate the horizontal **ADJUST** knob (◀▶) to select the baud rate. The available selections are **9600** (the default), **19200**, **38400**, and **115200**.
Rotate the vertical **ADJUST** knob (⬆⬇⬅) to select **RS232** or **RS422**.

Set DHCP Mode submenu

When Dynamic Host Configuration Protocol (DHCP) mode is enabled, the scaler ignores any entered IP address and obtains its IP address from a DHCP server (if the network is DHCP capable).

On the **Set DHCP Mode** screen, rotate either **ADJUST** knob to the right to turn DHCP on or to the left to turn DHCP off. Contact your system administrator for the setting to select.

Set IP Address submenu

Valid IP addresses consist of four one-, two-, or three-digit numeric sub-fields (called “octets”) that are separated by periods. Each octet can be numbered from 000 through 255 (leading zeros are inserted by the DVS). The factory-installed default address is **192.168.254.254**, but if this conflicts with other equipment at your installation, you can change the IP address to any valid value via the **Set IP Address** screen.

To change the unit IP address:

1. Press **NEXT** repeatedly until the **Set IP Address** screen is displayed.
2. Rotate the horizontal **ADJUST** knob (↕) to select an octet. (The selected octet blinks.)
3. Rotate the vertical **ADJUST** knob (◀▶) to increase or decrease the blinking number.

Set Subnet Mask submenu

The subnet mask is used to determine whether the DVS is on the same subnet as the mail server when you are using a subnet (see **Subnetting, a Primer** on page 118). The subnet mask address has the same validity rules as the IP address. The default subnet mask is 255.255.000.000.

To change the subnet mask:

1. Press **NEXT** repeatedly until the **Set Subnet Mask** screen is displayed.
2. Rotate the horizontal **ADJUST** knob (↕) to change the blinking octet selection.
3. Rotate the vertical **ADJUST** knob (◀▶) to increase or decrease the blinking number.

Set Gateway Addr submenu

The gateway address identifies the gateway to the mail server that will be used if the scaler and the mail server are not on the same subnet. The default gateway address is **000.000.000.000**.

To change the gateway address:

1. Press **NEXT** until the **Set Gateway Addr** screen is displayed.
2. Rotate the horizontal **ADJUST** knob (↕) to change the blinking octet selection.
3. Rotate the vertical **ADJUST** knob (◀▶) to increase or decrease the blinking number.

NOTE: The **Edit Comm Settings** menu has no MAC address screen, because the MAC address cannot be changed.

Exiting the Menu System

To exit the menu system, press the **MENU** button repeatedly until the **Exit MENU? Press NEXT** screen appears. Press the **NEXT** button to return to the default cycle.

Alternatively, wait until the menu system times out and the default cycle resumes (approximately 30 seconds).

Picture Controls

The DVS has six picture control buttons located on the front panel to the right of the PIP buttons. You can use these buttons to adjust size, position, brightness and contrast, color and tint, detail, magnification (zoom), and select a portion of the image on which to focus the view (pan). (See the [Picture Controls Summary](#) table on the next page for an explanation of these button functions.)

NOTE: When PIP mode is active, all these picture controls apply to the PIP window. To configure the main window, press the **PIP On/Off** button to exit PIP mode.

Adjusting the Picture Controls

To adjust the picture controls for the currently selected input:

1. Press the button for the input that you want to adjust. If you want to adjust the PIP window, press the **PIP On/Off** button to enter PIP mode, then press the button for the PIP input.
2. Press the desired picture control button: **Size**, **Bright/Cont** (brightness and contrast), **DETAIL** (sharpness), **Position** (centering), **Color/Tint** (color quality), or **Zoom/Pan** (magnification or horizontal and vertical panning).
3. Rotate the horizontal (◀▶) and vertical (⬆⬇⬅) **ADJUST** knobs to select a level from the available range.
4. Repeat steps 1 through 3 for each image adjustment you want to make for the selected input.

NOTE: The LCD screen displays N/A in place of a value if that adjustment does not apply to the video format of the input.

Picture Controls Summary

The following table explains the functions of the **Picture Controls** buttons and how to make adjustments. (In the Display column, *n* is a single digit, 0 through 9.)

Button	Display	Function	Range	Adjust Knob
Size	H Size V <i>nnnn</i> <i>nnnn</i>	Enlarge or shrink the image.	Min: 0 Max: 4095	H (width): Horizontal (◀▶) V (height): Vertical (⬆⬇)
Bright/Cont	Brit Cont <i>nnn</i> <i>nnn</i>	Brightness: Set the black level of the input. Contrast: Increase or decrease range of image light and dark values.	Brightness: 000 - 127 Default: 064 Contrast: 000 - 127 Default: 064	Brightness: Horizontal (◀▶) Contrast: Vertical (⬆⬇)
DETAIL	Detail <i>nnn</i>	Adjust image sharpness and noise reduction.	000 - 127 Default: 064	Either
Position	H Center V \pm <i>nnnn</i> \pm <i>nnnn</i>	Position image relative to display center.	Range: -2048 - +2048 Default: 0000	H: Horizontal (◀▶) V: Vertical (⬆⬇)
Color/Tint	Color Tint <i>nnn</i> <i>nnn</i>	Color: Adjust color intensity. (At lowest adjustment, all colors are shades of gray.) Tint: Change appearance of colors.	Color: 000-127 Default: 064 Tint: 000-127 Default: 064	Color: Horizontal (◀▶) Tint: Vertical (⬆⬇)
Zoom/Pan Press this button once to set Zoom, twice to set Pan.	Zoom: <i>nnn</i> %	Increase or decrease the size of the image while keeping the aspect ratio constant.	Min: 100% Max: 200% Default: 100%	Either
	H Pan: V \pm <i>nnn</i> \pm <i>nnn</i>	Move the focus on the image right, left, up, or down.	For H and V: -100 through +100 Default: 000	H: Horizontal (◀▶) V: Vertical (⬆⬇)

Input Presets

The DVS 510 Series has 128 input preset slots, which can save signal type, input configuration settings, and picture control settings for any of the inputs. These presets can be saved and recalled using the Windows-based control software (see the *Signal Processing Products Control Program* help file), SIS commands (see the [Input Presets commands](#) on page 65) or the DVS 510 Series web pages (see [Memory/Input Presets Page](#) on page 104).

The following settings are contained in the input presets:

- Input Type
- Color
- Horizontal Start
- Horizontal Position
- Preset Name*
- Tint
- Vertical Start
- Vertical Position
- Film Mode Detect
- Contrast
- Pixel Phase
- Horizontal size
- Zoom
- Brightness
- Total Pixels
- Vertical size
- Pan
- Detail Filter

*Can be set by SIS command only.

The 128 input presets are global, containing all of the settings for an input when the DVS is used with a matrix switcher. This allows a matrix switcher with multiple types of video inputs to be connected to the DVS 510 to expand the number of input video sources.

Each input should be switched into the DVS, configured, then saved as a preset for recall by a control system when that input is sent from the matrix switcher to any of the 10 DVS inputs.

- If an input preset is recalled to an input that does not support the input type saved in the preset, an SIS error code is returned.
- If the signal frequencies and total line count do not match the frequencies saved in the preset, the DVS uses the auto memories settings instead of recalling the preset. If no auto memory exists for the frequency, the DVS references its lookup table (a generic list of default sampling parameters embedded in the DVS).
- If the output rate does not match the output rate that was active when the preset was saved, all settings in the input preset are recalled except size and position.

Audio Functions

The DVS 510 Series provides three audio outputs: fixed, variable, and amplified (DVS 510 SA only). The following table shows the functions available on these audio outputs.

Function	Fixed Output	Variable Output	Amplified Output
Bass		X	X
Treble		X	X
Volume Level		X	X
Gain or Attenuation	X	X	X
Limiter			X
Audio Delay	X	X	X

(See [Audio Configuration Menu](#) on page 28 for information on adjustments to the functions listed in the table above.)

Volume Control

Rotating the **VOLUME** knob on the front panel increases and decreases the audio volume in up to 100 steps.

NOTE: This knob is speed sensitive, that is, you can turn the knob quickly to make coarse adjustments or slowly to make fine adjustments.

The table below shows some examples of the amount of rotation needed to achieve volume levels.

Volume Knob Rotations	Volume Level Steps (0–100)
½	25
1	50
1½	75
2	100

When this knob is turned, the LCD window displays a bar graph representation of the volume level for 0.5 seconds before returning to the previous menu. In addition, the step number is displayed at the top of the LCD screen.

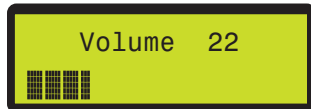

Figure 23. Example of the LCD Screen during Volume Adjustment

Volume adjustment can be made from the front panel at any time during scaler operation.

Volume LEDs

To the right of the **VOLUME** knob are three LEDs that indicate the volume level (see figure 24 on the next page):

- **Max (red)** — Lights steadily when the volume level is between 80% and 99%. When the volume is at 100% (maximum), this LED flashes.
- **Mid (green)** — Lights steadily when the volume level is above 49%.
- **Min (green)** — Lights steadily when the volume level is above 1%. When the volume is at 0 (minimum), this LED blinks. It also blinks when the audio is muted by SIS command (see the **Audio Mute** commands on page 64) or by the IR remote control (see **Using the Optional IR 904 Remote Control** on page 44).

NOTES:

- When the volume is muted, all the Volume LEDs go dark except Min, which blinks.
- When an incremental Volume LED lights, the LEDs below it remain lit. For example, when the Max LED lights, the Mid and Min LEDs are also lit.

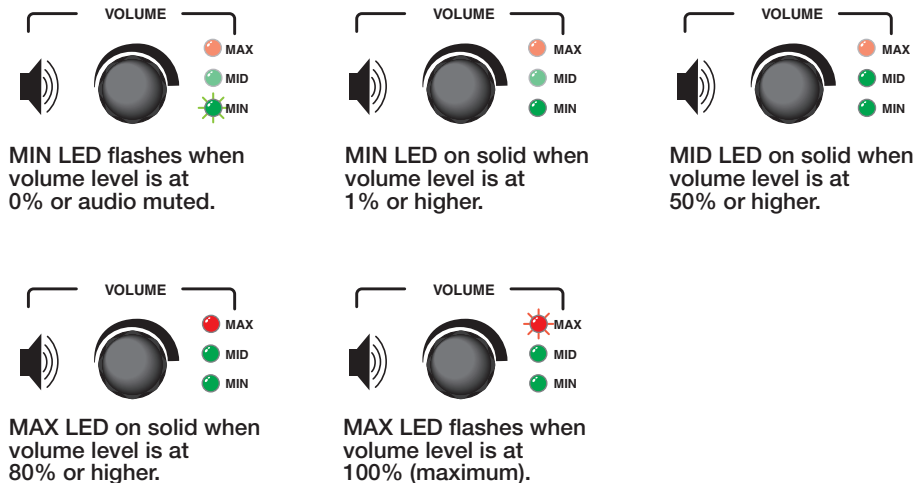

Figure 24. Volume Indicator LEDs on the Front Panel

Audio or Video Breakaway

To switch the audio or the video separately away from the current input to another input (audio or video breakaway), enter an audio **or** a video input selection SIS command (see the [Input Selection commands](#) on page 57). When the audio is switched from one input to another (audio breakaway), the audio switch effect is always a fade, regardless of the selected video effect. During audio or video breakaway, the audio input button lights red and the video button lights green. Audio or video breakaway is not available while the DVS is in PIP mode.

Resetting

The rear panel has a recessed **RESET** button that initiates various levels of resets. To select different reset levels, use a pointed stylus or small Philips screwdriver to press and hold the button while the DVS is running or press and hold the button while applying power to the scaler.

NOTE: You can also reset the unit to factory defaults using SIS commands (see the [Resets commands](#) on page 68) or from the front panel (see the [Reset to Factory screen](#) on page 33).

ATTENTION:

- Review the reset modes carefully. Using the wrong reset mode may result in unintended loss of flash memory programming, port reassignment, or scaler reboot. The [table on the next page](#) provides a summary of the reset modes.
- Analysez minutieusement les différents modes de réinitialisation (voir [tableau page suivante](#)). Appliquer le mauvais mode de réinitialisation peut causer une perte inattendue de la programmation de la mémoire flash, une reconfiguration des ports ou une réinitialisation du processeur.

NOTES:

- The reset modes listed in the table on the next page close all open IP and Telnet connections and all sockets.
- Each mode is a separate function, not a continuation from mode 1 to mode 5.
- There is no reset mode 2 for the DVS 510 Series.

DVS 510 Series Reset Mode Summary				
	Mode	Activation	Result	Purpose and Notes
Factory Firmware	1	Hold in the recessed RESET button while applying power to the unit.	The DVS reverts to the factory default firmware for a single power cycle. Event scripting does not start if the unit is powered on in this mode. All user files and settings (such as drivers, adjustments, and IP settings) are maintained.	Use mode 1 to revert to the factory default version for a single power cycle if incompatibility issues arise with user-loaded firmware.
Run and Stop Events	3	Hold in the RESET button for about 3 seconds until the Power LED blinks once, then release and press RESET momentarily (less than 1 second) within 1 second*.	Mode 3 turns events on or off. If the events are currently stopped after the momentary press, the power LED flashes twice, indicating the starting of events. If the events are currently running after the momentary press, the Power LED flashes three times indicating the stopping of events.	Mode 3 is useful for troubleshooting.
Reset All IP Settings	4	Hold in the RESET button for about 6 seconds until the Power LED blinks twice (once at 3 seconds, and again at 6 seconds). Then, release and press RESET momentarily (for less than 1 second) within 1 second*.	Mode 4 does the following: <ul style="list-style-type: none"> • Enables ARP capability. • Sets the IP address back to factory default (192.168.254.254). • Sets the subnet back to the factory default. • Sets the default gateway address to the factory default. • Sets port mapping back to factory default. • Turns DHCP off. • Turns events off. 	Mode 4 enables you to set IP address information using ARP and the MAC address.
Reset to Factory Defaults	5	Hold in the RESET button for about 9 seconds until the Power LED blinks three times (once at 3 seconds, again at 6 seconds, again at 9 seconds). Then, release and press RESET momentarily (for less than 1 second) within 1 second*.	Mode 5 performs a complete reset to factory defaults (except the firmware). <ul style="list-style-type: none"> • Does everything mode 4 does. • Clears port configurations. • Resets all IP options. • Clears all user settings. • Clears all files from the unit. 	Mode 5 is useful if you want to start over with configuration and uploading, and also to replace events.

*For modes 3, 4, and 5, nothing happens if the momentary press does not occur within 1 second.

Front Panel Lockout (Executive Mode)

To prevent accidental changes to settings, you can lock the DVS 510 front panel controls by placing the scaler in lock (executive) mode 1 or 2. While the DVS is in lock mode, RS-232, RS-422, and Ethernet communication, as well as IR remote control, remain available.

- Lock mode 1 locks all front panel functions. This mode can be enabled or disabled only by SIS commands (see the **Front Panel Security Lockout (Executive Mode)** commands on page 66 in the Command and Response Table for DVS 510 SIS Commands).
- Lock mode 2 locks all front panel functions except input selection, PIP, volume control, and Auto-Image. To enable lock mode 2, press and hold the **POSITION** and **SIZE** buttons simultaneously until **Executive Mode 2 Enabled** appears in the LCD window (approximately 2 seconds).

To exit lock mode 2, press and hold the **POSITION** and **SIZE** buttons again until **Executive Mode Disabled** appears in the LCD window (approximately 2 seconds).

NOTE: The IR receiver can be locked (default state) and unlocked via SIS commands (see the **IR Receiver commands** on page 67 in the Command and Response Table for DVS 510 SIS Commands).

Additional Features

The following features are available via one or more of the following: SIS commands, the Signal Processing Products Control Program, the DVS 510 HTML pages, or IR remote control. They cannot be accessed via the front panel.

Freeze

This function freezes the current image on the display. You can freeze and unfreeze the image using the Windows-based control software (see the SPPCP help file), SIS commands via an RS-232 or RS-422 connection (see the **Freeze** commands on page 65) or the Web pages (see **User Control Page** on page 101).

If you switch inputs while the image is frozen, the freeze mode is cancelled and the image from the new input is displayed.

Power Save Modes

When there is no active video for the current input, you can disable the output sync so that a display can go into a lower power or standby state. This can increase the life of the display panel or projector lamp. You can select the power save mode using SIS commands (see the **Power Save/Screen Saver** commands on page 62) or the Signal Processing Products Control Program (see the SPPCP help file). The power save options are:

- Mute video to black, retaining output sync.
- Display a blue screen.
- Display a blue screen for 1 minute, then mute all sync outputs.

Output Sync Mute

This function mutes all video and sync outputs, placing the display device in a power save mode. Output sync mute is available only via SIS commands (see the **Video Mute** commands on page 59).

NOTE: Individual outputs cannot be muted by this command. With the output sync mute enabled, all analog and digital outputs are simultaneously disabled.

Overscan Mode

This function allows you to set a default overscan of 0%, 2.5%, or 5% to apply to SMPTE input rates (NTSC, PAL, 480p through 1080p). When the overscan mode is **not** set to 0% and an auto-image is performed on a low-resolution or DVI input, the DVS uses the default values for input sizing and centering instead of performing a complete auto-image.

For YUV Auto and RGB inputs, pixel phase is included in the auto-image, regardless of the current overscan setting.

The overscan mode setting is adjusted per input type (composite, S-video, RGBcvs, YUV Auto, RGB, and DVI) using SIS commands (see the **Overscan Mode** commands on page 66).

Using the Optional IR 904 Remote Control

The optional hand-held IR 904 Remote Control provides a convenient means of remotely performing many of the functions that are also available through the front panel, SIS commands, the Windows-based control software, or the embedded web pages. The DVS responds to commands from remote control as if the corresponding button were pressed on the front panel or the corresponding SIS command or software selection were entered.

The IR receiver port on the front panel is located to the left of the CONFIG port. It receives signals from the remote control if they are sent from within a 40-degree arc to the right or left of direct line of sight between the remote control and the scaler IR sensor, and from no more than 30 feet (9 meters) away.

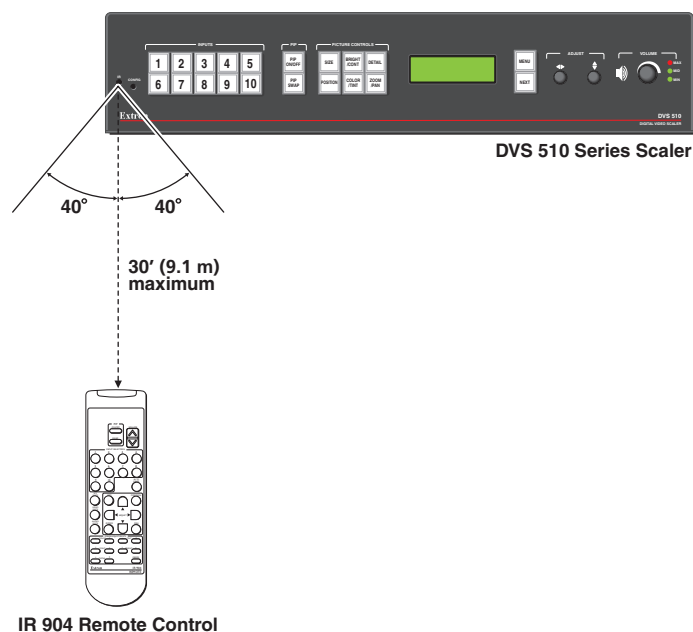

Figure 25. Area for Remote Signal Reception

Locking IR Remote Control Access

The DVS can be set to lock out users from using the IR 904 Remote Control to control the scaler. Remote access can be enabled and disabled via SIS commands (see the **IR Receiver** commands on page 67). When remote access is locked, all other controls remain available (SIS commands, Web pages, control software, and front panel).

NOTES:

- By default, the IR receiver is disabled.
- The DVS must be connected to power before you operate the remote control. Setup operations cannot be performed from the remote control.

Installing Batteries in the IR 904 Remote Control

Install two AAA batteries in the IR 904 Remote Control as shown below.

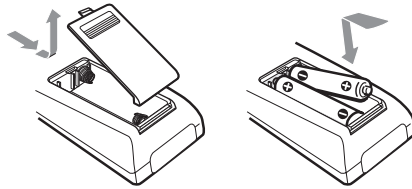
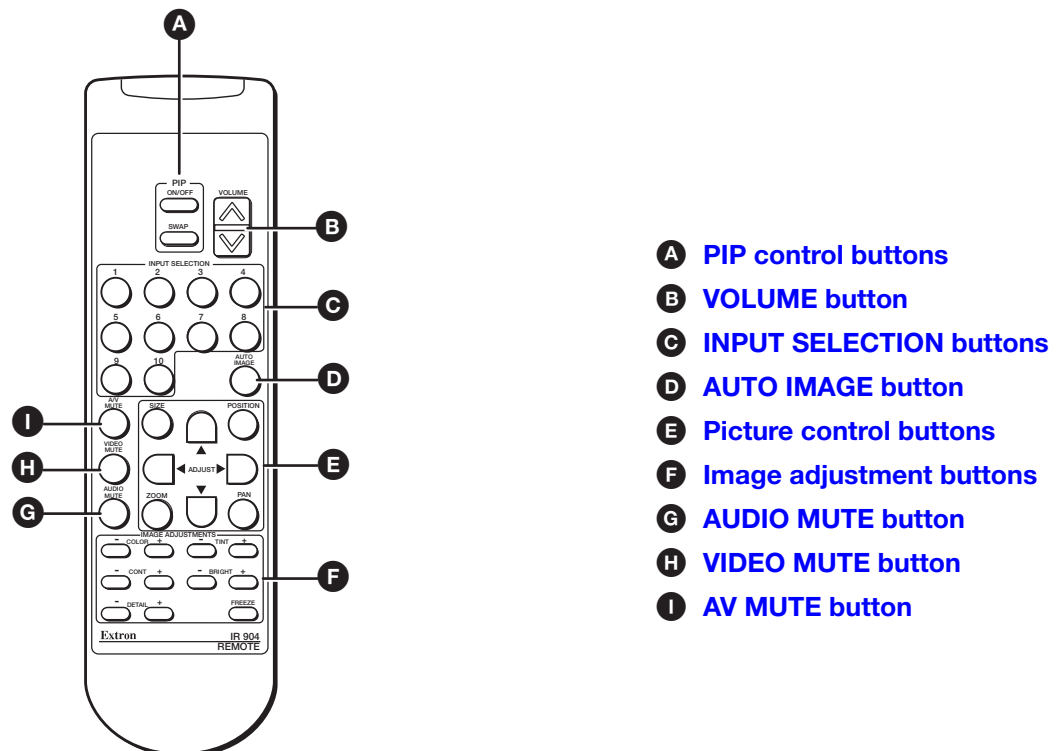

Figure 26. Installing Batteries in the IR 904 Remote Control

Buttons on the IR 904 Remote Control

The following DVS 510 Series functions are available through the buttons on the IR 904 IR Remote Control:



- A** PIP control buttons
- B** VOLUME button
- C** INPUT SELECTION buttons
- D** AUTO IMAGE button
- E** Picture control buttons
- F** Image adjustment buttons
- G** AUDIO MUTE button
- H** VIDEO MUTE button
- I** AV MUTE button

Figure 27. Buttons on the IR 904 Remote Control

- A PIP control buttons** — Control the picture-in-picture (PIP) function:
 - **PIP ON/OFF button** — Toggles between showing and hiding the picture-in-picture on the display (enabling and disabling PIP mode).
 - **PIP SWAP button** — Toggles the primary (main or background) and secondary (PIP) pictures between the main image and the PIP window.
- B VOLUME button** — Press the top (up arrow) or bottom (down arrow) of this rocker button to raise or lower the output volume level.
- C INPUT SELECTION buttons** — Press these buttons, numbered 1 through 10, to select the input.
- D AUTO IMAGE button** — Performs an Auto-Image on the current input (sizes and centers the image to fill the screen).
- E Picture control buttons** — Let you make adjustments to the image on the screen, including size, position, zoom, and pan. These buttons perform the same functions as their equivalent buttons on the front panel.

The four **ADJUST** buttons on the remote control perform the same functions as the horizontal and vertical **ADJUST** knobs on the front panel, that is, enabling you to select parameters and adjust them.

To adjust a picture control using the remote control buttons:

1. Aim the IR 904 remote control at the front panel IR sensor.
2. Press the **SIZE**, **POSITION**, **PAN**, or **ZOOM** button to select a picture control.
3. While watching the display, press repeatedly or press and hold the appropriate **ADJUST** button until the desired appearance is achieved.

The illustration at right and the table below show the buttons to use for each picture control adjustment.

- 1 SIZE button**
- 2 Vertical ADJUST buttons**
- 3 POSITION button**
- 4 Horizontal ADJUST buttons**
- 5 PAN button**
- 6 ZOOM button**

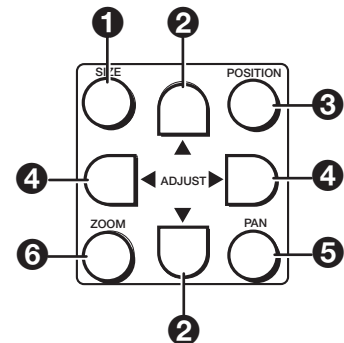

Button	Function	ADJUST Button
SIZE	Enlarge or shrink the image.	Horizontal size: ◀ ▶ Vertical size: ▼ ▲
POSITION	Position image relative to display center.	Horizontal position: ◀ ▶ Vertical position: ▼ ▲
ZOOM	Increase or decrease the size of the image while keeping the aspect ratio constant.	Either
PAN	Move the focus on the image right, left, up, or down.	Pan horizontally: ◀ ▶ Pan vertically: ▼ ▲

- F Image adjustment buttons** — Let you make adjustments to the appearance of the image on the screen, including color, tint, contrast, brightness, and sharpness (**DETAIL**). For each of these controls, there are two buttons: **+** to increase the image property and **-** to decrease it. You can also freeze the image on the screen (the **FREEZE** button has no equivalent on the front panel).

To adjust the image using the remote control buttons:

1. Aim the IR 904 remote control at the front panel IR sensor.
2. While watching the display, press repeatedly or press and hold the **+** or **-** button for the desired picture control until the desired appearance is achieved.

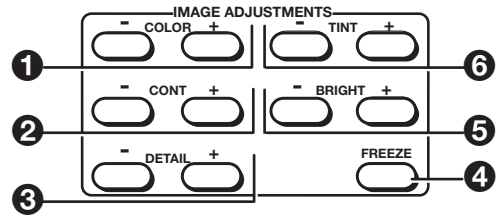

Figure 28. IR 904 Image Adjustment Buttons

- 1 COLOR buttons** — Adjust the color intensity (at the lowest level, all colors are shades of gray).
- 2 CONT buttons** — Increase or decrease the range of image light and dark values (contrast).
- 3 DETAIL buttons** — Adjust the sharpness of the image.
- 4 FREEZE button** — Freezes the image on the screen. To unfreeze the image, press this button again.
- 5 BRIGHT buttons** — Set the black level of the current input.
- 6 TINT buttons** — Change the appearance of the colors on the screen.
- G AUDIO MUTE button** — Toggles audio output muting on and off.
- H VIDEO MUTE button** — Toggles video output muting (hiding) on and off.
- I AV MUTE button** — Mutes and unmutes both video and audio simultaneously.

Remote Configuration and Control

The DVS 510 can be remotely controlled via a host computer or other device (such as a control system) attached to the rear panel RS232 connector, the front panel RS-232 CONFIG port, or the LAN port. You can configure and control the DVS by the Extron Simple Instruction Set (SIS) of commands, by using the Extron Windows-based Signal Processing Products Control Program (SPPCP), or by the internal HTML web pages (see [HTML Configuration and Control](#), beginning on page 87).

This section describes the serial and Ethernet connections through which the SIS commands can be issued, and lists the commands that are available for configuring and controlling the DVS 510 Series. It also provides instructions on obtaining and opening the control program. Topics include:

- [Serial Ports](#)
- [Ethernet Port](#)
- [Using SIS Commands](#)
- [Using the Signal Processing Products Control Program \(SPPCP\)](#)

Serial Ports

The DVS supports RS-232 and RS-422 serial communication protocols and can operate at 9600, 19200, 38400, or 115200 baud rates. (See [Edit Comm Settings Menu](#) on page 34 to configure this port using the front panel menus.)

The default protocol for the serial ports is 9600 baud, 1 stop bit, no parity, and no flow control. (See [RS-232 connector](#) or [Connecting to the RS-232 CONFIG Port \(Front Panel\)](#) on page 11 for the pin assignments for these two ports.)

Ethernet Port

The RJ-45 connector on the rear panel can be connected to an Ethernet LAN or WAN to enable control of the DVS via SIS commands or the Signal Processing Products Control Program. Communication between the scaler and the controlling device can be via a utility such as Extron DataViewer or HyperTerminal, or via Telnet (a TCP socket using port 23). The Telnet port number can be changed, if necessary, via SIS. (For information on connecting via Telnet, see [IP Addressing](#) on page 114.)

Ethernet Cable

The Ethernet cable must be properly terminated for your application as either a straight-through cable or a crossover cable. (For pin assignments for these cables, see [LAN connector](#) on page 10.)

IP Address

To access the DVS 510 or DVS 510 SA via the Ethernet port, obtain the IP address of the scaler from your network administrator. If the IP address has been changed to an address comprised of words and characters, you can determine the actual numeric IP address using the ping (ICMP) utility (see [IP Addressing](#) on page 114 for more details). If the IP address has not been changed, the factory-specified default is 192.168.254.254.

Establishing an Ethernet Connection Using TCP

Establish a network connection to a DVS as follows:

1. Open a TCP connection to port 23, using the IP address of the scaler.

The scaler responds with a copyright message that includes the date, the name of the product, firmware version, part number, and the current date and time (see [Scaler-initiated Messages](#) on the next page).

NOTE: If the scaler is not password-protected, the device is ready to accept SIS commands immediately after it sends the copyright message.

If the scaler is password-protected, a **password** prompt appears below the copyright message.

2. If the scaler is password protected, enter the appropriate administrator or user password.
3. If the password is accepted, the scaler responds with **Login User** or **Login Administrator**.
4. If the password is not accepted, the **Password** prompt reappears.

Connection Timeouts

The Ethernet link times out after a designated period of no communications. By default, this timeout value is set to 5 minutes, but the value can be changed (see the [Set current connection port timeout](#) command on page 74).

NOTE: Extron recommends leaving the default timeout at 5 minutes and periodically issuing the Query (**Q**) command to keep the connection active. If there are long idle periods, Extron recommends disconnecting and reopening the connection when another command must be sent.

Using SIS Commands

SIS commands consist of one or more characters per command field. They do not require any special characters to begin or end the command character sequence. When the DVS determines that a command is valid, it executes the command and sends a response to the host device. Each scaler response to an SIS command ends with a carriage return and a line feed (CR/LF = `]`), which signals the end of the response character string. A string is one or more characters.

Scaler-initiated Messages

When a local event such as a front panel input selection or adjustment takes place, the DVS responds by sending a message to the host. No response is required from the host. Some scaler-initiated messages are listed here.

- (c) Copyright 20nn, Extron Electronics, DVS 510, Vn.nn., 60-835-0n ↵
Www, DD Mmm YYYY hh:mm:ss ↵

The DVS sends the copyright message upon connecting to the computer via IP, or when powering up while connected. Vn.nn is the firmware version number.

- ↵ Password:

The ↵ Password: prompt requires a password (administrator level or user level) followed by a carriage return. The prompt is repeated if the correct password is not entered.

If the correct password is entered, the unit responds with:

```
↵*****  
↵Login Administrator↵  
or
```

```
↵*****  
↵Login User↵
```

depending on the password that was entered. If the passwords are the same for both the administrator and the user, the unit defaults to administrator privileges.

- In [x1] All ↵
Reconfig ↵

The DVS sends this response when an input is switched or when a new signal is detected. [x1] is the input number.

Error Responses

When the DVS receives a valid command, it executes the command and sends a response to the host device. If the unit is unable to execute the command because the command contains invalid parameters, it returns an error response to the host. The responses include:

Error numbers

- E01 — Invalid input number
- E10 — Invalid command
- E11 — Invalid preset number
- E12 — Invalid port number
- E13 — Invalid parameter
- E14 — Not valid for this configuration
- E17 — Invalid command for signal type
- E22 — Busy
- E24 — Privilege violation
- E25 — Device not present
- E26 — Maximum number of connections exceeded
- E27 — Invalid event number
- E28 — Bad filename or file not found

Error response references

- ¹⁴ = Commands that give an E14 (invalid command for this configuration) error if sent to a product whose current configuration does not support the command
- ²⁴ = Commands that give an E24 (privilege violation) error if you are not logged on at administrator level
- ²⁷ = Commands that may give an E27 (invalid event number) error
- ²⁸ = Commands that may give an E28 (file not found) error

Using the Command and Response Tables

These tables contain Telnet (port 23), serial, or web browser (port 80) commands. There are some minor differences between issuing these commands via Telnet and via URL encoding using a web browser. All commands work with either connection method but, due to some limitations of the web browser, the encapsulation characters are modified to make sure that the browser properly handles them.

NOTE: For web browsers, all non-alphanumeric characters must be represented as their hexadecimal equivalent. An example is the `%xx command`, where `xx` is the two-character representation of the hex byte that needs to be sent. (For example, a comma would be shown as `%2C`.)

Telnet:

Escape (Hex **1B**)
Carriage Return (Hex **0D**)

Web Browser:

W (must not be encoded)
Pipe Character (**|**) (must not be encoded)

When SIS commands are used through a web browser, the URL reference is used below to shorten the examples. In practice, this would be the full URL of the control interface and Web page reference, including all path information, for example, `http://192.168.254.254/index.html`

To send any of the commands using a web browser, prefix them with the full IP address, followed by `?cmd=`.

NOTE: With Telnet you can use either the Escape commands or the W commands, and the carriage return or the pipe (**|**) character. With the web browser you are required to use the W commands and the pipe character.

In either method, {Data} is data that is directed to a specified port and must be encoded if it is non-alphanumeric.

The **command and response tables for SIS commands**, starting on page 57, list the commands that the DVS 510 scaler recognizes as valid, the responses that are returned to the host, a description of the command function or the results of executing the command, and command examples.

NOTE: If the unit does not support or recognize a command that is entered, no action is taken and no response is returned.

ASCII to Hex Conversion Table																Esc 1B	CR 0D	LF 0A
Space →	20	!	21	"	22	#	23	\$	24	%	25	&	26	'	27			
	(28) 29	* 2A	+ 2B	, 2C	- 2D	. 2E	/ 2F										
	0 30	1 31	2 32	3 33	4 34	5 35	6 36	7 37										
	8 38	9 39	: 3A	; 3B	< 3C	= 3D	> 3E	? 3F										
	@ 40	A 41	B 42	C 43	D 44	E 45	F 46	G 47										
	H 48	I 49	J 4A	K 4B	L 4C	M 4D	N 4E	O 4F										
	P 50	Q 51	R 52	S 53	T 54	U 55	V 56	W 57										
	X 58	Y 59	Z 5A	[5B	\ 5C] 5D	^ 5E	_ 5F										
	` 60	a 61	b 62	c 63	d 64	e 65	f 66	g 67										
	h 68	i 69	j 6A	k 6B	l 6C	m 6D	n 6E	o 6F										
	p 70	q 71	r 72	s 73	t 74	u 75	v 76	w 77										
	x 78	y 79	z 7A	{ 7B	7C	} 7D	~ 7E	DEL 7F										

Figure 29. ASCII to Hexadecimal Character Conversion Table

NOTE: Upper- and lowercase text can be used interchangeably except where noted.

Symbol Definitions for DVS 510 Series SIS Commands

- = Space
- ↵ = Carriage return with line feed
- ← = Carriage return with no line feed
- | = Pipe (vertical bar) character. For URL-encoded commands, has the same function as ←.
- Esc** = Escape
- W = For URL-encoded commands, has the same function as **Esc**.
- ^{14, 24, 27, 28} = Superscripts indicate the error message displayed if the command is entered incorrectly or with invalid parameters (see [Error response references](#) on the previous page).
- X1** = Input selection
1 through 10
- X2** = Output selection
1 = DVI
2 = Top VGA connector
3 = Bottom VGA connector
- X3** = Input video format
1 = RGB
2 = YUVp/HDTV
3 = RGBcvS
4 = YUVi
5 = S-video
6 = Composite
7 = DVI
- X4** = H start
0 through 255
- X5** = V start
0 through 255
- X6** = Pixel phase
0 through 31
- X7** = Total pixels (±512 of default value for high resolution video and ±256 of the default value for low resolution video)

- X8** = Active pixels (± 512 of the default value for high resolution video and ± 256 of the default value for low resolution video)
- X9** = Active lines (± 256 of default value)
- X10** = On and off
 - \emptyset = Off or disable
 - 1 = On or enable
- X11** = Input standard
 - \emptyset = No signal
 - 1 = NTSC 3.58
 - 2 = PAL
 - 3 = NTSC 4.43
 - 4 = SECAM
 - = Not applicable (occurs when input is set to RGB or YUVp/HDTV)
- X12** = Internal temperature (in degrees Celsius)
- X14** = Input preset name
 - 16 characters maximum
 - ASCII characters **23** through **126** only
- X15** = Picture adjustment
 - \emptyset through **127**
- X16** = H and V position
 - Value based on the current output resolution
- X17** = H and V size
 - Value based on the current output resolution
- X18** = Zoom
 - 100% through 200%
- X19** = Pan
 - Value depends on the zoom setting.
- X20** = Test pattern

\emptyset = None	7 = White Field
1 = Color Bars	8 = Crop
2 = Crosshatch	9 = 1.33 Aspect Ratio
3 = 4x4 Crosshatch	10 = 1.78 Aspect Ratio
4 = Grayscale (16 level)	11 = 1.85 Aspect Ratio
5 = Ramp	12 = 2.35 Aspect Ratio
6 = Alternating Pixels	13 = Blue Mode

- X21** = Output resolution and EDID emulation
 Ø = Automatic (Match current scaler output resolution — default)
 1Ø-9Ø = See the EDID table below.

SIS Variables for EDID Resolution and Refresh Rate Combination									
Resolution	23.98 Hz	24 Hz	25 Hz	29.97 Hz	30 Hz	50 Hz	59.94 Hz	60 Hz	75 Hz
640 x 480						1Ø		11	12
800 x 600						13		14	15
852 x 480						16		17	18
1024 x 768						19		2Ø	21
1024 x 852						22		23	24
1024 x 1024						25		26	27
1280 x 768						28		29	3Ø
1280 x 800						31		32	33
1280 x 1024						34		35	36
1360 x 765						37		38	39
1360 x 768						4Ø		41	42
1365 x 768						43		44	45
1365 x 1024						49		5Ø	51
1366 x 768						46		47	48
1400 x 1050						55		56	
1440 x 900						52		53	54
1600 x 1200						59		6Ø	
1680 x 1050						57		58	
1920 x 1200						61		62	
480p							63	64	
576p						65			
720p			66	67	68	69	7Ø	71	
1080i						72	73	74	
1080p	75	76	77	78	79	8Ø	81	82	
2048 x 1080	83	84	85	86	87	88	89	9Ø	

- X23** = Output polarity
 0 = H- / V- (default)
 1 = H- / V+
 2 = H+ / V-
 3 = H+ / V+

- X24** = Output sync format
 Ø = RGBHV (default)
 1 = RGBS
 2 = RGsB
 3 = YUV bi-level
 4 = YUV tri-level

- X25** = User presets
1 through 16
The following parameters are saved in user presets:
- Color
 - Tint
 - Contrast
 - Brightness
 - DETAIL
 - Horizontal position
 - Vertical position
 - Horizontal size
 - Vertical size
 - Pan
 - Zoom
- X26** = Input presets
1 through 128
The following parameters are saved in input presets:
- Input type
 - Preset name
 - Film mode detect
 - Color
 - Tint
 - Contrast
 - Brightness
 - DETAIL
 - Horizontal start
 - Vertical start
 - Active pixels
 - Active lines
 - Pixel phase
 - Total pixels
 - Horizontal position
 - Vertical position
 - Horizontal size
 - Vertical size
 - Zoom
 - Pan
- X30** = PIP window input selection
0 through 10
0 = No selection: PIP disabled
- X37** = RGB delay
0 through 50 in 0.1 second increments. Default is **05** (0.5 seconds).
- X38** = Overscan
Applies only to SMPTE input rates (NTSC, PAL, 480p, 576p, 720p, 1080i, and 1080p).
0 = 0.0% (default for RGB and DVI). A true Auto-Image is executed on SMPTE inputs.
1 = 2.5% (default for YUVp/HDTV). An Auto-Image command snaps to a 2.5% table.
2 = 5.0% (default for composite, S-video, YUVi, and RGBcvS). An Auto-Image command snaps to a .0% table.
- X39** = Aspect ratio
1 = Fill — Each input rate fills the entire output raster (default).
2 = Follow — Each input rate is displayed with its native aspect ratio.
- X40** = Power save (screen saver) modes
0 = Black screen — The scaler continues to provide output sync and muted video with no video input (default).
1 = Blue screen — The scaler provides a blue output while still providing continuous sync.
2 = Timed blue screen — The scaler shows blue output for 1 minute, then mutes output video and sync.
- X42** = Video mute
0 = Unmute
1 = Mute to black
2 = Mute output video and sync
- X44** = HDCP/signal status
0 = No receiver or source device detected (analog or digital inputs or outputs)
1 = Receiver or source detected with HDCP (digital inputs or outputs only)
2 = Receiver or source detected but no HDCP present (analog or digital inputs or outputs)

- X45** = Video switching effect
 - 0 = Cut — Instantly switches video.
 - 1 = Fade — Video fades to black, then fades to the new input.
- X50** = Audio volume
 - Range of 0 through 100
- X51** = Audio output format
 - 1 = Mono
 - 2 = Stereo (default)
- X52** = Audio gain level
 - 0 through 12 dB (decibels above zero)
- X53** = Audio attenuation level
 - 12 through 0 dB (decibels below zero)
- X54** = Audio gain or attenuation level
 - Unit response, can be positive or negative.
- X55** = Audio treble and bass
 - Range = 0 through 16 in 1.5 dB increments (-12 dB through +12 dB)
 - 0 = -12 dB
 - 8 = 0 dB (default)
 - 16 = +12 dB
- X57** = PIP Audio source
 - 0 = Follow main window (default).
 - 1 = Follow PIP window.
- X58** = Digital audio input type
 - 2 = Digital, 2-channel LPCM 48 kHz (default)
 - 3 = Digital, full audio (7.1, DTS, and so on)
- X59** = Front panel security lock (executive mode)
 - 0 = Disabled — Full front panel access (default)
 - 1 = Lock mode 1 — All front panel functions locked
 - 2 = Lock mode 2 — Limited front panel access (input selection, PIP, volume control, and Auto-Image)

Command and Response Table for DVS 510 Series SIS Commands

Command	ASCII Command (Host to Scaler)	Response (Scaler to Host)	Additional Description
Input Selection			
Video and audio	$\boxed{x1}$!	In $\boxed{x1}$ • A11 ↵	Select video and audio from input source $\boxed{x1}$.
Video	$\boxed{x1}$ &	In $\boxed{x1}$ • RGB ↵	Select video from input source $\boxed{x1}$.
Audio	$\boxed{x1}$ \$	In $\boxed{x1}$ • Aud ↵	Select audio from input source $\boxed{x1}$.
NOTES:			
<ul style="list-style-type: none"> When the DVS is in PIP mode, the input selection command affects the PIP window. In addition, all picture controls and advanced input settings apply to the PIP input. Query commands (!, &, and \$) return the full tagged response as seen in verbose modes 2 and 3. However, responses that include only the $\boxed{x1}$ variable are returned in verbose mode 0 or 1 (not tagged). 			
Input Video Format			
Set video format	$\boxed{x1}$ * $\boxed{x3}$ \	Typ $\boxed{x1}$ * $\boxed{x3}$ ↵	Set input $\boxed{x1}$ to video format $\boxed{x3}$.
View video format	$\boxed{x1}$ \	$\boxed{x3}$ ↵	View video type of input $\boxed{x1}$.
Input EDID (Inputs 5, 6, 8, and 10 only – DVI and VGA)			
Specify an EDID value	\boxed{Esc} A $\boxed{x1}$ * $\boxed{x21}$ EDID ←	Edid A $\boxed{x1}$ * $\boxed{x21}$ ↵	Set the EDID resolution and refresh rate for input $\boxed{x1}$ to $\boxed{x21}$.
View EDID data	\boxed{Esc} A $\boxed{x1}$ EDID ←	$\boxed{x21}$ ↵ <i>In verbose mode:</i> Edid A $\boxed{x1}$ * $\boxed{x21}$ ↵	View the EDID setting for input $\boxed{x1}$.
Auto-Image			
Enable Auto-Image	$\boxed{x1}$ * 1 A	Img $\boxed{x1}$ * 1 ↵	Perform Auto-Image on input $\boxed{x1}$ when it is selected or when a new signal is applied.
Disable Auto-Image	$\boxed{x1}$ * 0 A	Img $\boxed{x1}$ * 0 ↵	Turn off Auto-Image for input $\boxed{x1}$.
View Auto-Image	$\boxed{x1}$ A	$\boxed{x1}$ ↵	View the current Auto-Image setting for input $\boxed{x1}$.
Execute an Auto-Image	A	Img ↵	Perform an Auto-Image for the current input.
Execute and fill	1 * A	Img 1 ↵	Perform an Auto-Image on the current input and fill the entire output display.
Execute and follow	2 * A	Img 2 ↵	Perform an Auto-Image on the current output and follow the aspect ratio of the input.

NOTE: $\boxed{x1}$ = Input selection
 $\boxed{x3}$ = Input video format
 $\boxed{x21}$ = EDID resolution and refresh rate

1 through 10
1 = RGB, 2 = YUVp/HDTV, 3 = RGBcvS, 4 = YUVi, 5 = S-video, 6 = Composite video, 7 = DVI
See the [EDID resolution table](#) on page 54 for the available values.

Command	ASCII Command (Host to Scaler)	Response (Scaler to Host)	Additional Description
Horizontal Start			
Specify a value	Esc X4 HSRT ←	Hsrt X1 * X4 ↵	Set the horizontal location of the first active pixel in the active window to X4 .
Increment value	Esc + HSRT ←	Hsrt X1 * X4 ↵	Increment the horizontal start position.
Decrement value	Esc – HSRT ←	Hsrt X1 * X4 ↵	Decrement the horizontal start position.
View horizontal start	Esc HSRT ←	X4 ↵	Show the horizontal location of the first active pixel in the active window.
Vertical Start			
Specify a value	Esc X5 VSRT ←	Vsrt X1 * X5 ↵	Set the vertical location of the first active line in the active window to X5 .
Increment value	Esc + VSRT ←	Vsrt X1 * X5 ↵	Increment vertical start position.
Decrement value	Esc – VSRT ←	Vsrt X1 * X5 ↵	Decrement vertical start position.
View vertical start	Esc VSRT ←	X5 ↵	Show the vertical location of first active line in the active window.
Pixel Phase (available only for RGB and YUVp/HDTV input signals)			
Specify a value	Esc X6 PHAS ←	Phas X1 * X6 ↵	Adjust the pixel phase value to X6 .
Increment value	Esc + PHAS ←	Phas X1 * X6 ↵	Increase the pixel phase.
Decrement value	Esc – PHAS ←	Phas X1 * X6 ↵	Decrease the pixel phase.
View pixel phase	Esc PHAS ←	X6 ↵	Show the pixel phase.
Total Pixels (available only for RGB and YUVp/HDTV input signals)			
NOTE: The total pixels value (X7) is based on the current input resolution.			
Specify a value	Esc X7 TPIX ←	Tpix X1 * X7 ↵	Adjust total pixels to X7 for active input.
Increment value	Esc + TPIX ←	Tpix X1 * X7 ↵	Increase the total pixels.
Decrement value	Esc – TPIX ←	Tpix X1 * X7 ↵	Decrease the total pixels.
View total pixels	Esc TPIX ←	X7 ↵	Show the total pixels.
Active Pixels			
Specify a value	Esc X8 APIX ←	Apix X1 * X8 ↵	Adjust the active pixels value to X8 .
Increment value	Esc + APIX ←	Apix X1 * X8 ↵	Increase the active pixels.
Decrement value	Esc – APIX ←	Apix X1 * X8 ↵	Decrease the active pixels.
View active pixels	Esc APIX ←	X8 ↵	Show the active pixels.

NOTE:

X1 = Input selection	1 through 10
X4 = Horizontal start	0 through 255
X5 = Vertical start	0 through 255
X6 = Pixel phase	0 to 31
X7 = Total pixels	±512 of the default value for high resolution video and ±127 for interlaced video
X8 = Active pixels	±512 of the default value for high resolution video and ±127 for interlaced video

Command	ASCII Command (Host to Scaler)	Response (Scaler to Host)	Additional Description
Active Lines			
Specify a value	Esc X9 ALIN ←	Alin X1 * X9 ↵	Adjust the active lines value to X9 .
Increment value	Esc + ALIN ←	Alin X1 * X9 ↵	Increase the number of active lines.
Decrement value	Esc – ALIN ←	Alin X1 * X9 ↵	Decrease the number of active lines.
View active lines	Esc ALIN ←	X9 ↵	Show the number of active lines.
Film Mode Detect (3:2 pulldown detection)			
Enable	Esc X1 * 1 FILM ←	Film X1 * X10 ↵	Enable Film mode detection (auto sense for 3:2 or 2:2 pulldown) for input X1 .
Disable	Esc X1 * Ø FILM ←	Film X1 * X10 ↵	Disables Film mode detect for input X1 .
View setting	Esc X1 FILM ←	X10 ↵	View the current film mode detect setting. For X10 : 0 = Film mode detection off. 1 = film mode detection on.
Video Mute			
Mute video to black	1B	Vmt1 ↵	Mute the video and display a black screen.
Mute video and sync	2B	Vmt2 ↵	Mute the video and sync on all outputs.
Unmute video and sync	ØB	VmtØ ↵	Disable all mutes.
View mute status	B	X42 ↵	View mute status X42 .
Picture Controls			
Color (available for NTSC composite and S-video only)			
Specific value	Esc X15 COLR ←	Colr X1 * X15 ↵	Set the color level to X15 .
Increment up	Esc + COLR ←	Colr X1 * X15 ↵	Select the next higher color level.
Increment down	Esc – COLR ←	Colr X1 * X15 ↵	Select the next lower color level.
View color setting	Esc COLR ←	X15 ↵	View the current color setting.
Tint (available for NTSC composite and S-video only)			
Specific value	Esc X15 TINT ←	Tint X1 * X15 ↵	Set the tint level to X15 .
Increment up	Esc + TINT ←	Tint X1 * X15 ↵	Select the next higher tint level.
Increment down	Esc – TINT ←	Tint X1 * X15 ↵	Select the next lower tint level.
View tint setting	Esc TINT ←	X15 ↵	View the current tint setting.

NOTE:

X1	= Input selection	1 through 1Ø
X9	= Active lines	±256 of the default value
X10	= On and off	Ø = off, 1 = on
X15	= Picture adjustments	Ø through 127 (for color, tint, contrast, brightness, and detail filter)
X42	= Video mute status	Ø = unmuted, 1 = muted to black screen, 2 = all output video and sync muted

Command	ASCII Command (Host to Scaler)	Response (Scaler to Host)	Additional Description
Picture Controls (continued)			
Contrast			
Specific value	Esc X15 CONT ←	Cont X1 * X15 ←	Set the contrast level to X15 .
Increment up	Esc + CONT ←	Cont X1 * X15 ←	Select the next higher contrast level.
Increment down	Esc – CONT ←	Cont X1 * X15 ←	Select the next lower contrast level.
View contrast setting	Esc CONT ←	X15 ←	View the current contrast setting.
Brightness			
Specific value	Esc X15 BRIT ←	Brit X1 * X15 ←	Set the brightness level to X15 .
Increment up	Esc + BRIT ←	Brit X1 * X15 ←	Select the next higher brightness level.
Increment down	Esc – BRIT ←	Brit X1 * X15 ←	Select the next lower brightness level.
View brightness setting	Esc BRIT ←	X15 ←	View the current brightness setting.
Detail filter			
Set detail level	Esc X15 HDET ←	Hdet X1 * X15 ←	Set the detail (sharpness) level to X15 .
Increment up	Esc + HDET ←	Hdet X1 * X15 ←	Increase the detail level.
Increment down	Esc – HDET ←	Hdet X1 * X15 ←	Decrease the detail level.
View detail value	Esc HDET ←	X15 ←	Show the detail setting.
Horizontal Shift (Center)			
NOTE: The horizontal and vertical shift range (X16) is based on the current output resolution.			
Specific value	Esc X16 HCTR ←	Hctr X1 * X16 ←	Set the horizontal centering to X16 .
Increment up	Esc + HCTR ←	Hctr X1 * X16 ←	Shift the displayed window right.
Increment down	Esc – HCTR ←	Hctr X1 * X16 ←	Shift the displayed window left.
View shift	Esc HCTR ←	X16 ←	View horizontal centering value X16 .
Vertical Shift (Center)			
NOTE: The horizontal and vertical shift range (X16) is based on the current output resolution.			
Specific value	Esc X16 VCTR ←	Vctr X1 * X16 ←	Set the vertical centering to X16 .
Increment up	Esc + VCTR ←	Vctr X1 * X16 ←	Shift the displayed window down.
Increment down	Esc – VCTR ←	Vctr X1 * X16 ←	Shift the displayed window up.
View shift	Esc VCTR ←	X16 ←	View vertical centering value X16 .
Horizontal Size			
NOTE: The horizontal and vertical size range (X17) are based on the current output resolution.			
Specific value	Esc X17 HSIZ ←	Hsiz X1 * X17 ←	Set the window width to X17 .
Increase size	Esc + HSIZ ←	Hsiz X1 * X17 ←	Widen the window.
Decrease size	Esc – HSIZ ←	Hsiz X1 * X17 ←	Narrow the window.
View	Esc HSIZ ←	X17 ←	View horizontal sizing (width) value X17 .

NOTE: X1 = Input selection	1 through 10
X15 = Picture adjustments	0 through 127 (for color, tint, contrast, brightness, and detail filter)
X16 = Horizontal and vertical shift (center)	Range depends on the current output rate.
X17 = Horizontal and vertical size (width and height)	Range depends on the current output rate.

Command	ASCII Command (Host to Scaler)	Response (Scaler to Host)	Additional Description
Vertical Size			
NOTE: The vertical size range (X17) is based on the current output resolution.			
Specific value	Esc X17 VSIZ ←	Vsiz X1 * X17 ←	Set the window height to X17.
Increase size	Esc + VSIZ ←	Vsiz X1 * X17 ←	Make the window taller.
Decrease size	Esc – VSIZ ←	Vsiz X1 * X17 ←	Make the window shorter.
View	Esc VSIZ ←	X17 ←	View vertical sizing (height) value X17.
Zoom			
Set specific zoom value	Esc X18 ZOOM ←	Zoom X1 * X18 ←	Set the zoom percentage to X18.
Zoom in	Esc + ZOOM ←	Zoom X1 * X18 ←	Zoom in and make the image larger.
Zoom out	Esc – ZOOM ←	Zoom X1 * X18 ←	Zoom out and make the image smaller.
View zoom	Esc ZOOM ←	X18 ←	View the zoom percentage.
Pan			
NOTE: The pan value (X19) is based on the current zoom setting.			
Set horizontal value	Esc X19 HPAN ←	Hpan X1 * X19 ←	Set the horizontal pan value to X19.
Right	Esc – HPAN ←	Hpan X1 * X19 ←	Set the value to pan to the right.
Left	Esc + HPAN ←	Hpan X1 * X19 ←	Set the value to pan to the left.
View horizontal pan value	Esc HPAN ←	X19 ←	View the horizontal pan value.
Set vertical pan value	Esc X19 VPAN ←	Vpan X1 * X19 ←	Set the vertical pan value to X19.
Up	Esc – VPAN ←	Vpan X1 * X19 ←	Set the value to pan upward.
Down	Esc + VPAN ←	Vpan X1 * X19 ←	Set the value to pan downward.
View vertical pan value	Esc VPAN ←	X19 ←	View the vertical pan value.
Output Scaler Rate			
Set output rate	Esc X21 RATE ←	Rate X21 ←	Select an output resolution and refresh rate (see the EDID resolution table for SIS commands on page 54).
View output rate	Esc RATE ←	X21 ←	Show the selected output rate.

NOTE: X1 = Input selection
X17 = Horizontal and vertical size
X18 = Zoom value
X19 = Pan value
X21 = EDID resolution and refresh rate

1 through 10
(Width and height) Values depend on current output rate.
100% through 200%
-100 through +100 (Values depend on the zoom setting.) Default = 0.
See the **EDID resolution table** on page 54 for the available values.

Command	ASCII Command (Host to Scaler)	Response (Scaler to Host)	Additional Description																																	
Output Sync Format and Polarity																																				
Set sync format	Esc X24 0SYN ←	0syn X24 ↵	Set the sync format for the VGA output to X24 .																																	
NOTE: Setting the sync format to YUV bi-level and tri-level also affects the colorspace of the DVI output.																																				
View sync format	Esc 0SYN ←	X24 ↵	View the current output sync format.																																	
Set polarity	Esc X23 0POL ←	0pol X23 ↵	Set the sync polarity for the VGA output to X23 .																																	
View polarity	Esc 0POL ←	X23 ↵	View the output video and sync polarity.																																	
Power Save / Screen Saver																																				
NOTE: The action initiated by these commands takes place when there is no active video on the selected input.																																				
Video mute	Esc 0 PSAV ←	Psav 0 ↵	Mute the video output and retain the output sync (default). The screen is black.																																	
Blue output	Esc 1 PSAV ←	Psav 1 ↵	Set the video output to blue.																																	
Blue output and timeout	Esc 2 PSAV ←	Psav 2 ↵	Set the video output to blue for 1 minute, then mute the output video and sync.																																	
View setting	Esc PSAV ←	X40 ↵	View the current power save mode.																																	
Picture-in-Picture (PIP)																																				
PIP on	Esc X1 PIP ←	Pip X1 ↵	Enable picture-in-picture with input X1 as the PIP input.																																	
NOTES:																																				
<ul style="list-style-type: none"> When PIP is enabled, all picture control commands apply only to the image in the PIP window. If input X1 is in the same high or low resolution category as the currently displayed input, the error code E13 (invalid parameter) is returned. The table below shows the categories for each input. 																																				
<table border="1"> <thead> <tr> <th>Input</th> <th>High Resolution</th> <th>Low Resolution</th> </tr> </thead> <tbody> <tr> <td>1</td> <td></td> <td>Composite</td> </tr> <tr> <td>2</td> <td></td> <td>Composite</td> </tr> <tr> <td>3</td> <td></td> <td>S-video</td> </tr> <tr> <td>4</td> <td></td> <td>S-video</td> </tr> <tr> <td>5</td> <td>RGB, YUVp/HDTV</td> <td>YUVi, RGBcvS</td> </tr> <tr> <td>6</td> <td>RGB, YUVp/HDTV</td> <td>YUVi, RGBcvS</td> </tr> <tr> <td>7</td> <td>RGB, YUVp/HDTV</td> <td>YUVi, RGBcvS</td> </tr> <tr> <td>8</td> <td>DVI (all formats)</td> <td></td> </tr> <tr> <td>9</td> <td>RGB, YUVp/HDTV</td> <td>YUVi, RGBcvS</td> </tr> <tr> <td>10</td> <td>DVI (all formats)</td> <td></td> </tr> </tbody> </table>				Input	High Resolution	Low Resolution	1		Composite	2		Composite	3		S-video	4		S-video	5	RGB, YUVp/HDTV	YUVi, RGBcvS	6	RGB, YUVp/HDTV	YUVi, RGBcvS	7	RGB, YUVp/HDTV	YUVi, RGBcvS	8	DVI (all formats)		9	RGB, YUVp/HDTV	YUVi, RGBcvS	10	DVI (all formats)	
Input	High Resolution	Low Resolution																																		
1		Composite																																		
2		Composite																																		
3		S-video																																		
4		S-video																																		
5	RGB, YUVp/HDTV	YUVi, RGBcvS																																		
6	RGB, YUVp/HDTV	YUVi, RGBcvS																																		
7	RGB, YUVp/HDTV	YUVi, RGBcvS																																		
8	DVI (all formats)																																			
9	RGB, YUVp/HDTV	YUVi, RGBcvS																																		
10	DVI (all formats)																																			
PIP off	Esc 0 PIP ←	Pip 0 ↵	Disable PIP.																																	
NOTE:																																				
<table> <tr> <td>X1 = Input selection for PIP</td> <td>1 through 10</td> </tr> <tr> <td>X23 = Output polarity</td> <td>0 = H-/V- (default), 1 = H-/V+, 2 = H+/V-, 3 = H+/V+</td> </tr> <tr> <td>X24 = Output sync format</td> <td>0 = RGBHV (default), 1 = RGBS, 2 = RGSB, 3 = YUV bi-level, 4 = YUV tri-level</td> </tr> <tr> <td>X40 = Power save and screen saver modes</td> <td>0 = Black screen; output sync retained, 1 = Blue screen, continuous sync, 2 = Timed blue screen. Screen is blue for 1 minute, then output video and sync are muted.</td> </tr> </table>				X1 = Input selection for PIP	1 through 10	X23 = Output polarity	0 = H-/V- (default), 1 = H-/V+, 2 = H+/V-, 3 = H+/V+	X24 = Output sync format	0 = RGBHV (default), 1 = RGBS, 2 = RGSB, 3 = YUV bi-level, 4 = YUV tri-level	X40 = Power save and screen saver modes	0 = Black screen; output sync retained, 1 = Blue screen, continuous sync, 2 = Timed blue screen. Screen is blue for 1 minute, then output video and sync are muted.																									
X1 = Input selection for PIP	1 through 10																																			
X23 = Output polarity	0 = H-/V- (default), 1 = H-/V+, 2 = H+/V-, 3 = H+/V+																																			
X24 = Output sync format	0 = RGBHV (default), 1 = RGBS, 2 = RGSB, 3 = YUV bi-level, 4 = YUV tri-level																																			
X40 = Power save and screen saver modes	0 = Black screen; output sync retained, 1 = Blue screen, continuous sync, 2 = Timed blue screen. Screen is blue for 1 minute, then output video and sync are muted.																																			

Command	ASCII Command (Host to Scaler)	Response (Scaler to Host)	Additional Description
Picture-in-Picture (PIP) (continued)			
View PIP input	[Esc] PIP ←	[X1] ←	View the input in the PIP window.
Swap	%	Tke ←	Exchange the displayed content between the main and PIP windows.
Audio Commands			
Audio Volume			
Set output volume	[X50] V	Vol [X50] ←	Set the volume for the output to [X50] .
Increment volume	+ V	Vol [X50] ←	Increase the audio volume.
Decrement volume	- V	Vol [X50] ←	Decrease the audio volume.
View volume	V	[X50] ←	Show the current volume setting.
Audio Gain and Attenuation (per input)			
NOTE: The set gain (G) and set attenuation (g) commands are case sensitive . The increment, decrement, and view commands are not .			
Set audio gain	[X52] G	In [X1] • Aud [X54] ←	Set audio gain level to [X52] dB.
<i>Example</i>	5G	In [X1] • Aud5 ←	Set the audio gain to 5 dB.
Set attenuation	[X53] g	In [X1] • Aud [X54] ←	Set attenuation to [X53] dB.
<i>Example</i>	15g	In [X1] • Aud -15 ←	Set the audio attenuation to -15 dB.
Increment level	+ G	In [X1] • Aud [X54] ←	Increase the audio level by 1 dB.
Decrement level	- G	In [X1] • Aud [X54] ←	Decrease the audio level by 1 dB.
View	G	[X54] ←	View the current audio level.
Audio Bass (global)			
Set the bass level	[X55] <	Bas [X55] ←	Set the global bass level to [X55] .
<i>Example</i>	10 <	Bas 010 ←	Set the bass level to +3 dB.
Increment bass	+ <	Bas [X55] ←	Increase the bass level.
Decrement bass	- <	Bas [X55] ←	Decrease the bass level.
View bass level	<	[X55] ←	Show the current bass level.
Audio Treble (global)			
Set the treble level	[X55] >	Trb [X55] ←	Set the global treble level to [X55] .
Increment treble	+ >	Trb [X55] ←	Increase the treble level.
Decrement treble	- >	Trb [X55] ←	Decrease the treble level.
View treble level	>	[X55] ←	Show the current treble level.
Power Amp Limiter (DVS 510 SA only)			
Enable	[Esc] 1 APWR ←	Apwr 1 ←	Enable the power amp limiter to detect and eliminate clipping distortion.
Disable	[Esc] 0 APWR ←	Apwr 0 ←	Disable the power amp limiter.
View setting	[Esc] APWR ←	[X10] ←	Show current power amp limiter setting.
NOTE:			
[X1]	= PIP input selection	1 through 10	
[X10]	= Limiter on and off	0 = off, 1 = on	
[X50]	= Audio volume level	0 through 100	
[X52]	= Audio gain level	0 through 12 dB (dependent of resolutions)	
[X53]	= Audio attenuation level	0 through 12 dB (decibels below 0)	
[X54]	= Audio gain or attenuation (unit response)	- 12 dB through +12 dB (can be positive or negative)	
[X55]	= Audio bass and treble	0 through 16 (-12 dB through +12 dB) in increments of 1.5 dB	
		0 = -12 dB, 8 = 0 dB (default), 16 = 12 dB	

Command	ASCII Command (Host to Scaler)	Response (Scaler to Host)	Additional Description
Audio Commands (continued)			
Limit Audio Level on Power-up			
Set power-up limit	[Esc] [X50] ALMT ←	Almt [X50] ↵	Set the maximum volume level at power-up to [X50] .
View setting	[Esc] ALMT ←	[X50] ↵	Show the current power-up volume limit.
Audio Input Format (for embedded digital audio source)			
Set digital 2-channel audio	[Esc] I 2 AFMT ←	Afmt I 2 ↵	Select digital 2-channel audio EDID (default).
Set full digital audio	[Esc] I 3 AFMT ←	Afmt I 3 ↵	Select full digital audio EDID.
View	[Esc] I AFMT ←	[X58] ↵	Show selected digital audio EDID type.
Audio Output Format			
Set format	[Esc] 0 [X51] AFMT ←	Afmt 0 [X51] ↵	Select variable and amplified output signal format [X51] .
View	[Esc] 0 AFMT ←	[X51] ↵	Show selected audio output format.
Audio Mute			
Enable mute	1 Z	Amt 1 ↵	Mute the current input.
Disable mute	Ø Z	Amt Ø ↵	Unmute the current input.
View mute status	Z	[X10] ↵	Show the mute status. For [X10] : Ø = mute off, 1 = mute on.
Audio Delay			
Enable audio delay	[Esc] 1 ADLY ←	Adly 1 ↵	Enable audio delay to compensate for the time needed to process the input signal.
Disable audio delay	[Esc] Ø ADLY ←	Adly Ø ↵	Disable audio delay.
View	[Esc] ADLY ←	[X10] ↵	Show the status of audio delay. For [X10] : Ø = audio delay disabled 1 = audio delay enabled
Audio Follow			
Set audio follow	[Esc] [X57] AFLW ←	Aflw [X57] ↵	Select source [X57] for the audio.
View	[Esc] AFLW ←	[X57] ↵	Show the current audio source.
Presets			
User Presets			
Recall user preset	1 * [X25] .	1 Rpr [X25] ↵	Recall user preset [X25] for selected input.
Save user preset	1 * [X25] ,	1 Spr [X25] ↵	Save user preset [X25] for the selected input (see the User presets symbol definitions on page 55 for the saved parameters).

NOTE: **[X10]** = Audio mute or delay status
[X25] = User preset number
[X50] = Audio volume level
[X51] = Audio format
[X57] = Audio source
[X58] = Digital audio input type

Ø = unmuted or disabled, 1 = muted or enabled
1 through 16
Ø through 1ØØ
1 = mono, 2 = stereo
Ø = follow main window, 1 = follow PIP window
2 = digital, 2-channel LPCM 48 kHz (default)
3 = digital full audio (7.1, DTS, and so on)

Command	ASCII Command (Host to Scaler)	Response (Scaler to Host)	Additional Description
Presets (continued)			
Input Presets			
Recall input preset	2 * X26 .	2 Rpr X26 ↵	Recall input preset X26 .
Save input preset	2 * X26 ,	2 Spr X26 ↵	Save the parameters of the current input to preset X26 (for saved parameters, see Input presets symbol definition on page 55).
Input Preset Name			
Write preset name	Esc X26 , X14 NP ←	Nmp X26 , X14 ↵	Set name of preset X26 to X14 . The command character is a comma. Presets can have up to 16 characters.
NOTE: The following characters are invalid in input preset names: ~ @ = ` [] { } <> ' ' " " ; (semicolon) : (colon) / \ ? and space.			
View preset name	Esc X26 NP ←	X14 ↵	View the name of input preset X26 .
NOTE: To clear an input preset name, enter one space character for X14 .			
Auto Memories			
Enable	Esc 1 AMEM ←	Amem 1 ↵	Enable auto memories to automatically recall the previous settings for the incoming signal (default).
Disable	Esc Ø AMEM ←	Amem Ø ↵	Disable auto memories. Input presets must be manually recalled to configure the input.
View setting	Esc AMEM ←	X10 ↵	View the status of auto memories.
Advanced Configuration			
Test Pattern			
Set test pattern	Esc X20 TEST ←	Test X20 ↵	Select test pattern X20 .
View test pattern	Esc TEST ←	X20 ↵	View the current test pattern.
Freeze			
Set freeze	1 F	Frz 1 ↵	Freeze the selected input.
Set freeze	Ø F	Frz Ø ↵	Unfreeze the selected input.
View	F	X10 ↵	Show the freeze status (1= on, Ø= off).
RGB Delay Time			
Set RGB delay	Esc X37 VDLY ←	Vdly X37 ↵	Set the time the DVS will delay displaying the new input to X37 .
View setting	Esc VDLY ←	X37 ↵	View the RGB delay setting.

NOTE:

X10	= Auto memories or freeze status	Ø = disabled, 1 = enabled
X14	= Input preset name	Up to 16 characters; no special characters
X20	= Test pattern	Ø through 13 (see the Test pattern symbol definitions on page 53.
X26	= Input preset number	1 through 128
X37	= RGB delay amount	Ø through 5Ø in 0.1-second increments. Default is Ø5 (0.5 seconds)

Command	ASCII Command (Host to Scaler)	Response (Scaler to Host)	Additional Description
Advanced Configuration (continued)			
Front Panel Security Lockout (Executive Mode)			
Set mode 1	1 X	Exe 1 ↵	Lock all front panel functions.
Set mode 2	2 X	Exe 2 ↵	Allow limited adjustments to be made from the front panel (input switching, PIP, volume control, and Auto-Image).
Disable	Ø X	Exe Ø ↵	Allow all front panel adjustments.
View status	X	[X59] ↵	Show current lock mode status.
Input Aspect Ratio			
Set to Fill	[Esc] 1 ASPR ←	Aspr 1 ↵	Set the input to always fill the entire output raster (default).
Set to Follow	[Esc] 2 ASPR ←	Aspr 1 ↵	Display the input with its native aspect ratio.
View aspect ratio	[Esc] ASPR ←	Aspr [X39] ↵	View the current aspect ratio setting.
Overscan Mode			
NOTE: Overscan mode applies only to SMPTE input rates (NTSC, PAL, 480p, 576p, 720p, 1080i, and 1080p).			
Set value	[Esc] [X3] * [X38] OSCN ←	Oscn [X3] * [X38] ↵	Set input signal type [X3] to overscan mode [X38].
View status	[Esc] [X3] OSCN ←	Oscn [X3] * [X38] ↵	Show overscan status for input type [X3].
HDCP Notification			
Enable HDCP notification	[Esc] N 1 HDCP ←	Hdcp N 1 ↵	Enable HDCP notification (default). A full-screen green signal and an on-screen message are displayed when an HDCP compliant source is switched to a non-compliant display.
Disable notification	[Esc] N Ø HDCP ←	Hdcp N Ø ↵	Disable HDCP notification; mute output instead.
View notification status	[Esc] N HDCP ←	[X10] ↵	View HDCP notification status

NOTE: [X3] = Input signal type
 [X10] = HDCP notification status
 [X38] = Overscan setting

[X39] = Aspect ratio
 [X59] = Front panel lock (executive mode)

1 = RGB, 2 = YUVp/HDTV, 3 = RGBcvS, 4 = YUVi, 5 = S-video, 6 = Composite, 7 = DVI
 Ø = disabled, 1 = enabled
 Ø = 0.0% (default for RGB and DVI). A true Auto-Image is executed on SMPTE inputs.
 1 = 2.5% (default for YUVp/HDTV). An Auto-Image command snaps to a 2.5% table.
 2 = 5.0% (default for composite, S-video, YUVi, and RGBcvS). An Auto-Image command snaps to a 5.0% table.
 1 = Fill: each input rate fills the entire output raster (default).
 2 = Follow: each input rate is displayed with its native aspect ratio.
 Ø = executive mode disabled, 1 = full front panel lockout, 2 = Partial front panel lockout (Only input selection, PIP, volume control, and Auto-Image are available.)

Command	ASCII Command (Host to Scaler)	Response (Scaler to Host)	Additional Description
Advanced Configuration (continued)			
HDCP Signal Status			
Query input	Esc I HDCP ←	X44 ↵	Request the HDCP signal status of the current input.
Query output	Esc O HDCP ←	X44 ↵	Request the HDCP signal status of the DVI output.
Video Switch Effect			
NOTE: The video switch effect also affects the audio switch, as discussed in the following command descriptions.			
Cut	Esc Ø SWEF ←	Swe f Ø ↵	Set the video switch effect to cut . The audio output is instantly switched to the next input.
Fade		Swe f 1 ↵	Set the video switch effect to Fade (default). The audio ramps down from the current input, then ramps up to the new input.
View effect	Esc SWEF ←	X45 ↵	Show the current switch effect.
IR Receiver			
Enable receiver	65 * 1 #	IRDisable 1 ↵	Enable the IR receiver on the DVS front panel.
Disable receiver	65 * Ø #	IRDisable Ø ↵	Disable the IR receiver (default).
View IR receiver status	65 #	X10 ↵	View IR receiver status.
Information Request			
General information	I	Vid X1 • Aud X1 • Pip X1 • Typ X3 • Std X11 ↵	View the following device information: Vid = video input Aud = audio input Pip = PIP input Typ = video signal type Std = video standard (X11)
Query firmware version	Q	n . nn ↵	View the current firmware version.
Query part number	N	6Ø - 835 - nn ↵	DVS 510 = 60-835-01 DVS 510 SA = 60-835-02
View internal temp.	Esc 2ØSTAT ←	X12 ↵	View the internal temperature in degrees Celsius (response contains leading zeros).
NOTE:			
X1 = Input selection		1 through 1Ø	
X3 = Input signal type		1 = RGB, 2 = YUVp/HDTV, 3 = RGBcvS, 4 = YUVi, 5 = S-video, 6 = Composite, 7 = DVI	
X10 = IR receiver status		Ø = IR receiver disabled, 1 = IR receiver enabled	
X11 = Input video standard		Ø = No signal, 1 = NTSC 3.58, 2 = PAL, 3 = NTSC 4.43, 4 = SECAM	
X12 = Internal temperature		– = Not applicable (occurs when the input is set to RGB or YUVp/HDTV)	
X44 = HDCP signal status		Shown in degrees Celsius with leading zeros	
		Ø = No receiver or source device detected (analog or digital inputs or outputs)	
		1 = Receiver or source detected with HDCP/DPCP (digital inputs or outputs only)	
		2 = Receiver or source detected but no HDCP/DPCP is present (analog or digital inputs or outputs)	
X45 = Video switching effect		Ø = Cut. Instantly switches audio output to the next input.	
		1 = Fade. Audio ramps down from the current input, then ramps up to the new input (default).	

Command	ASCII Command (Host to Scaler)	Response (Scaler to Host)	Additional Description
Resets			
Erase flash memory ²⁴	Esc ZFFF ←	Zpf ↵	Clear all data from flash memory.
Reset audio settings	Esc ZA ←	Zpa ↵	Reset the audio input gain and global treble and bass settings to 0.
Reset all audio settings	Esc ZAAA ←	Zaa ↵	Reset all audio settings to the factory defaults.
Reset all settings to factory defaults	Esc ZXXX ←	Zpx ↵	Reset all settings and adjustments to the factory default settings.
Absolute system reset	Esc ZQQQ ←	Zpq ↵	Reset all settings and adjustments to the factory defaults, the IP address to 192.168.254.254 , and the subnet mask to 255.255.0.0 .
System reset retaining IP settings	Esc ZY ←	Zpy ↵	Reset all settings and adjustments to the factory default settings except IP settings: IP address, subnet mask, gateway IP address, unit name, DHCP setting, and port mapping (Telnet, Web, and direct access). This preserves communication with the device, and is recommended after a firmware update.

Symbol Definitions for IP-specific SIS Commands

- = Space
- ↵ = Carriage return with line feed
- ← = Carriage return with no line feed
- | = Pipe (vertical bar) character. For URL-encoded commands, has the same function as ↵.
- Esc** = Escape
- W = For URL-encoded commands, has the same function as E
- ^{14, 24, 27, 28} = Superscripts indicate the error message displayed if the command is entered incorrectly or with invalid parameters (see [Error response references](#) on page 51).

- X1** = Input selection
1 through 10
- X10** = On and off
0 = Off or disable
1 = On or enable
- X71** = Port number
01–99 (represented as two ASCII characters with leading zero if required)
- X72** = Command data section
Factory default name (model name + last three pairs of MAC address)
- X73** = GMT offset
–12.0 through +14.0. Represents hours and minutes offset from Greenwich mean time (GMT).
- X81** = Firmware version number *n.nn* (listed to two decimal places)
- X82** = Unit name
Up to 24 characters: alphabetical (A–Z or a–z), digits (0–9), or hyphen (-).

NOTES:

- The following characters are invalid or not recommended in names:
{space} + ~ , @ = ` [] { } < > ' ' “ ” ; : | \ and ?.
- The first character must be alphabetical.
- The last character must **not** be a hyphen.

- X83** = Local date and time format
For setting:
 In the format *MM/DD/YY•HH:MM:SS*
MM = month: **10** (January) through **12** (December)
DD = **01** through **31**
YY = **00** through **99**
HH = **00** through **23**
MM = **00** through **59**
SS = **00** through **59**
For reading:
 In the format *Day,•DD•Mmm•YYYY•HH:MM:SS*:
Day = weekday: **Mon** through **Sun**
DD = **01** through **31**
Mmm = month: (**Jan** through **Dec**)
YYYY = year: **2000** through **2099**
HH = hour: **00** through **23**
MM = minutes: **00** through **59**
SS = seconds: **00** through **59**
- X84** = IP address (*nnn.nnn.nnn.nnn*)
 (Leading zeros in each of the four fields are optional for setting values and are suppressed in returned values.)
 Factory default IP address: **192.168.254.254**
 Default broadcast IP address: **255.255.255.255**
- X87** = Time (in 10-ms increments) to wait for characters to arrive at a serial port before terminating the connection
10 through **32767**
 Default = **10**, or 100 ms
- X88** = Time (in 10-ms increments) to wait between characters before terminating the connection
2 through **32767**
 Default = **2**, or 20 ms
- X89** = Hardware (MAC) address
00-05-A6-xx-xx-xx
- X90** = Subnet mask (*nnn.nnn.nnn.nnn*)
 (Leading zeros in each of the four fields are optional for setting values and are suppressed in returned values.)
 Factory default subnet mask: **255.255.0.0**
- X91** = Message length, delimiter value, or byte count (via the serial port). (This parameter is optional.)
nL = Length of message to be received. For the length,
n = byte count (**1** through **32767**, default is **0**).
nD = Delimiter value

- X92** = Verbose mode
 Ø = Clear or none (default for Telnet connection)
 1 = Verbose mode (default for RS-232 and RS-422)
 2 = Tagged responses for queries
 3 = Verbose mode and tagged responses for queries

NOTES:

- If **verbose mode** is enabled (modes 1 and 3), you are shown all actions (commands) initiated by other users via the web, RS-232/RS-422, or the front panel. (This does not include information requests.)
- If **tagged responses** are enabled (modes 2 and 3), the unit responds to all read or view commands with the command text as well as the value or information requested.

For example, the View Name command **Esc** CN ← returns Ipn • **X82** ← instead of the name only (**X82**).

- X93** = Priority status for receiving timeouts
 1 = Use **Send data string** parameters (if they exist) (default).
 2 = Use **Configure receive timeout** command parameters instead.
- X95** = Baud rate
 9600 (default), 19200, 38400, or 115200
- X96** = Parity (Only the first letter is required.)
Odd, **E**ven, **N**one (default), **M**ark, **S**pace
- X97** = Data bits
 7 or 8 (default)
- X98** = Stop bits
 1 (default) or 2
- X99** = Port type
 Ø = RS-232 (default)
 1 = RS-422
- X100** = Flow control (Only the first letter is required.)
Hardware, **S**oftware, **N**one (default)
- X101** = Data pacing
 Specified in milliseconds between bytes:
 0000 through 1000 (default = 0 ms)
- X102** = Password
 12 characters maximum

NOTE: The following characters are invalid in passwords:
 {space} + ~ , @ = ` [] { } < > ‘ ’ “ ” ; : | \ and ?.

- X103** = Daylight saving time
 Ø = off or ignore
 1 = USA (begins second Sunday in March and ends first Sunday in November.)
 2 = Europe (Begins last Sunday in March and ends last Sunday in October.)
 3 = Brazil (Begins third Sunday in October and ends third Sunday in February.)
- X104** = Event number
 Ø through 99 (The event must be running.)

- X105** = Event buffer
 - Ø = receive
 - 1 = unified
 - 2 = data
 - 3 = NVRAM
- X106** = Event buffer offset
 - Ø through maximum buffer size
- X107** = Event data size
 - b** = bit
 - B** = byte (8 bits)
 - S** = short (16 bits)
 - L** = long (32 bits)

NOTE: In a write operation, this parameter can optionally be preceded by **A** (for **and**) or **O** (for **or**) to logically combine with content instead of replacing it.

- X108** = Event data to write
- X109** = Reading password
 - If a password exists, the unit responds with the password (RS-232 connection) or 4 asterisks (****) (IP connection). If there is no password, the response is empty.
- X110** = Number of bytes to read
 - 1 through 127
- X115** = Default unit name
 - Combination of the model name and the last three pairs of the unit MAC address
 - Example: DVS-51Ø-SA-Ø5-62-3D)**
- X118** = Security level of connection
 - Ø = Anonymous
 - Ø1–1Ø = Extended security levels
 - 11 = User
 - 12 = Administrator
- X120** = ASCII digits representing numeric value of data element read from event buffer. (Leading zeros are suppressed.)
- X125** = Broadcast repetition rate in seconds
 - Ø through 255
 - Default = Ø (clear)
 - (The response is returned with leading zeros.)
- X127** = Threshold settings for all ports
 - Ø = None
 - 1 = Full
 - 2 = Standby and full
- X129** = Number of seconds before IP connection timeout
 - 1 through 65ØØØ
 - Default = 3Ø = 300 seconds
- X133** = Hardware (MAC) address with the four most significant hex nibbles converted into a single 16-bit decimal number.
- X134** = Hardware (MAC) address with the 8 least significant hex nibbles converted into a single 32-bit decimal number. Can be up to 10 digits.

Command and Response Table for IP-Specific SIS Commands

Command	ASCII Command (Host to Scaler)	Response (Scaler to Host)	Additional Description
Bidirectional Serial Port			
Send data string	[Esc] [X71] * [X87] * [X88] * [X91] RS ←	RS ← [X72] <i>response from command</i> ←	
Configure port type	[Esc] [X1] * [X71] CY ←	Cpn [X1] • Cty [X71] ←	Configure port [X71] as RS-232 or RS-422.
Configure port parameters ²⁴	[Esc] [X71] * [X95], [X96], [X97], [X98] CP ←	Cpn [X71] • [X95], [X96], [X97], [X98] ←	Set baud rate [X95], parity [X96], [X97] data bits, and [X98] stop bits for port [X71]. [X95] = 9600, 19200, 38400, or 115200 (default = 9600) [X96] = O dd, E ven, N one, M ark, or {space}. (Only the first letter is required.) [X97] = Data bits: 7 or 8 (default = 8) [X98] = Stop bits: 1 or 2 (default = 1)
View port parameters	[Esc] [X71] CP ←	[X95], [X96], [X97], [X98] ←	
Configure flow control ²⁴	[Esc] [X71] * [X100], [X101] CF ←	Cpn [X71] • Cfl [X100], [X101] ←	Set flow control type [X100] for port [X71] with [X101] ms between bytes. For [X100]: H = Hardware S = Software N = None (default) [X101] = 0000 through 0001 (default = 0 ms)
View flow control	[Esc] [X71] * CF ←	[X100], [X101] ←	
Configure receive timeout ²⁴	[Esc] [X71] * [X87] * [X88] * [X93] * [X91] CE ←	Cpn [X71] • Cce [X87], [X88], [X93], [X91] CE ←	
NOTES:			
[X87] = Time in tens of milliseconds that the DVS will wait for receipt of the first response character before terminating the command. (Default = 1 = 10 ms, max. = 32767)			
[X88] = Time in tens of milliseconds that the DVS will wait between characters being received via a serial port before terminating the current command or receive operation. (Default = 2 = 20 ms; max. = 32767.)			
[X91] = #L or #D. The letter parameter is case sensitive (requires capital D or capital L). For [X91]: L = Length of the message to be received, D = Delimiter value. A delimiter of ASCII 0A = 10D. # = Byte count (for L) or a single ASCII character expressed in decimal form (for D). Byte count # can be 0 through 32767, default = 0. The ASCII decimal # can be 0 through 00255, default = the byte count. Example: A 3-byte length = 3L. (The response includes leading zeros.)			
[X93] = Priority status for port [X71] receiving timeouts. For [X93]: 0 = Use Send data string command parameters (default); 1 = Use Configure receive timeout command parameters. (The response includes leading zeros.)			
View receive timeout	[Esc] [X71] CE ←	[X87], [X88], [X93], [X91] ←	

Command	ASCII Command (Host to Scaler)	Response (Scaler to Host)	Additional Description
Ethernet Data Port			
Set current connection port timeout	Esc 0 * X129 TC ←	Pti0 * X129 ←	Set number of seconds (in tens of seconds) before timeout on IP connections. X129 = 1 through 65000.
View current connection port timeout	Esc 0 TC ←	X129 ←	
Set global port timeout	Esc 1 * X129 TC ←	Pti1 * X129 ←	
View global port timeout	Esc 1 TC ←	X129 ←	
IP Setup Commands			
Set unit name	Esc X82 CN ←	Ipn • X82 ←	Set DVS unit name X82 . X82 can be up to 24 characters consisting of A to Z, a to z, 0 through 9, and hyphen (-). The first letter must be alphabetical; the last one must not be a hyphen.
View unit name	Esc CN ←	X82 ←	
Reset unit name to factory default ²⁴	Esc • CN ←	Ipn • X115 ←	Reset DVS name to its factory default name X115 . X115 consists of the model name and the last three pairs of the MAC address.
<i>Example:</i>	Esc • CN ←	Ipn • DVS-510-SA-05-62-3D ←	
Set time and date ²⁴	Esc X83 CT ←	Ipt X83 ←	X83 is the local date and time format. The set format is MM/DD/YY-HH:MM:SS . (The hours, minutes, and seconds can also be separated by periods.) <i>Examples:</i> 11 / 13 / 06 - 10 : 54 : 00 or 11 / 13 / 06 - 10 . 54 . 00
View time and date	Esc CT ←	X83 ←	
Set GMT offset ²⁴	Esc X73 CZ ←	Ipz X73 ←	Set the Greenwich Mean Time (GMT) offset value (X73) for the DVS location. GMT offset (-12.00 to +14.00) represents the time difference in hours and minutes (± hh:mm relative to Greenwich, England). The plus sign and leading zero are optional. X73 is in the format hh:mm. <i>Example:</i> 5 : 30 or 5 . 30 = +05 : 30
NOTE: In the command, the divider between hours and minutes can be a colon or a period. In the response, it is a colon.			
<i>Example:</i>	Esc 8 . 0 CZ ←	Ipz + 08 : 00 ←	
View GMT offset	Esc CZ ←	X73 ←	

Command	ASCII Command (Host to Scaler)	Response (Scaler to Host)	Additional Description
IP Setup Commands (continued)			
Set Daylight Saving Time ²⁴	Esc X103 CX ←	Ipx X103 ↵	Set daylight saving time X103 : Ø = off or ignore 1 = USA (Begins second Sunday in March and ends first Sunday in November.) 2 = Europe (Begins last Sunday in March and ends last Sunday in October.) 3 = Brazil (Begins third Sunday in October and ends third Sunday in February.)
View Daylight Saving Time	Esc CX ←	X103 ↵	
Set DHCP on ²⁴	Esc 1DH ←	Idh1 ↵	Set Dynamic Host Configuration Protocol (DHCP) to On. The DVS automatically obtains its IP address from the local network.
Set DHCP off ²⁴	Esc ØDH ←	IdhØ ↵	Set DHCP to Off.
View DHCP mode	Esc DH ←	X10 ↵	For X10 : 1 = DHCP is on. Ø = DHCP is off.
Set IP address	Esc X84 CI ←	Ipi • X84 ↵	X84 = IP address (<i>nnn.nnn.nnn.nnn</i>). Leading zeros in the octets are optional.
View IP address	Esc CI ←	X84 ↵	Leading zeros are suppressed in returned values.
View hardware (MAC) address	Esc CH ←	X89 ↵ In verbose mode: Iph • X89 ↵	X89 = hardware media access control (MAC) address (<i>xx-xx-xx-xx-xx-xx</i>).
View number of open connections	Esc CC ←	<i>Number of connections</i> In verbose mode: Icc <i>Number of connections</i> ↵	
Set subnet mask	Esc X90 CS ←	Ips • X90 ↵	X90 = subnet mask (<i>nnn.nnn.nnn.nnn</i>). Syntax is the same as for IP addresses. Leading zeros are optional in the octets.
View subnet mask	Esc CS ←	X90 ↵	Leading zeros are suppressed in returned values.
Set gateway IP address	Esc X84 CG ←	Ipg X84 ↵	X84 = IP address (<i>nnn.nnn.nnn.nnn</i>). Leading zeros are optional.
View gateway IP address	Esc CG ←	X84 ↵	Leading zeros are suppressed in returned values.
Set DNS server IP address	Esc X84 DI ←	Ipd • X84 ↵	Set the IP address X84 for the Domain Name System (DNS) in the format (<i>nnn.nnn.nnn.nnn</i>). Leading zeros in the octets are optional.
View DNS server IP address	Esc DI ←	X84 ↵	Leading zeros are not shown response.

Command	ASCII Command (Host to Scaler)	Response (Scaler to Host)	Additional Description
IP Setup Commands (continued)			
Set verbose mode	Esc X92 CV ←	Vrb X92 ↵	Set verbose mode X92 . For X92 : Ø = verbose mode and tagged responses disabled 1 = verbose mode 2 = tagged responses for queries 3 = verbose mode and tagged responses for queries Default is Ø for Telnet connections and 1 for RS-232 or RS-422 control.
NOTES:			
<ul style="list-style-type: none"> If verbose mode is enabled (modes 1 and 3), you are shown all actions (commands) initiated by other users via the web, RS-232, RS-422, or the front panel. (This does not include information requests.) If tagged responses are enabled (modes 2 and 3), the unit responds to all read or view commands with the command text as well as the value or information requested. For example, the view name command Esc CN ← returns Ip n • X82 ↵ instead of the name only (X82). 			
View verbose mode	Esc CV ←	X92 ↵	
Set broadcast mode	Esc X125 , X84 ←	Bmd X125 , X84 ↵	
Set broadcast mode to default address	Esc X125 EB ←	Bmd X125 , X84 ↵	
Clear broadcast mode	Esc ØEB ←	BmdØØØ, X84 ↵	
View broadcast mode	Esc EB ←	Bmd X125 , X84 ↵	
Set broadcast port and MAC address	Esc X72 * X133 * X134 PB ←	Bpt X72 * X89 ↵	X72 = UDP outgoing port X133 * X134 = MAC address for UDP unicast transmissions
Set event target IP address	Esc X104 , X84 ID ←	E di X104 * X84 * X72 ↵	X104 = event number (The event must be running.) X74 = Ø–99
Set event target TCP port	Esc X104 , X72 ID ←	E di X104 * X84 * X72 ↵	
Set event target IP address	Esc X104 ID ←	X84 * X72 ↵	
Password and Security Settings			
Set administrator password ²⁴	Esc X102 CA ←	Ipa • X109 ↵	Set administrator access password X102 . X102 = 4 to 12 alphanumeric characters. The password is case sensitive. Special characters (spaces or symbols) are not allowed. X109 = password. If a password exists, the unit responds with the password (RS-232 or RS-422 connection) or 4 asterisks (****) (IP connection). If there is no password, the response is empty.
View administrator password ²⁴	Esc CA ←	X109 ↵	
Reset (clear) administrator ²⁴ password	Esc • CA ←	Ipa • ↵	Clear or remove all passwords (administrator and user).

Command	ASCII Command (Host to Scaler)	Response (Scaler to Host)	Additional Description
Password and Security Settings (continued)			
Set user password ¹⁴	Esc X102 CU ←	Ipu • X109 ↵	Set user access password X102 . X102 = 4 to 12 alphanumeric characters. The password is case sensitive. Special characters (spaces or symbols) are not allowed. X109 = password. If a password exists, the unit responds with the password (RS-232 or RS-422 connection) or 4 asterisks (****) (IP connection). If there is no password, the response is empty.
NOTE: A user password cannot be assigned if an administrator password does not exist. Entering a password when the DVS has not been configured yields an E14 error response from the scaler. If the administrator password is cleared (removed), the user password is removed also.			
View user password	Esc CU ←	X109 ↵	
Reset (clear) user password	Esc • CU ←	Ipu • ↵	Clear or remove the user password.
Query session security level	Esc CK ←	X118 ↵ <i>In verbose mode:</i> Pv1 X118 ↵	
Remap Port Destinations			
Set Telnet port map ²⁴	Esc X72 MT ←	Pmt X72 ↵	X72 = Telnet port number
Reset Telnet port map ²⁴	Esc 23MT ←	Pmt00032 ↵	
Disable Telnet port	Esc 0MT ←	Pmt00000 ↵	
View Telnet port mapping	Esc MT ←	X72 ↵	
NOTES:			
<ul style="list-style-type: none"> • Duplicate port number assignments are not permitted (for example, the Telnet and web mapping cannot be the same). An E13 (invalid parameter) error code results. • Remapping of the port number other than to reset it to defaults 80 or 23 or to disable it by resetting it to 0 can be done only to ports numbered 1024 or higher. 			
Set web port map ²⁴	Esc X72 MH ←	Pmh X72 ↵	
Reset web port map ²⁴	Esc 80MH ←	Pmh00080 ↵	
Disable web port ²⁴	Esc 0MH ←	Pmh00000 ↵	
View web port map ²⁴	Esc MH ←	X72 ↵	
Set Direct Access port map ²⁴	Esc X72 MD ←	Pmd X72 ↵	
Reset Direct Access port map ²⁴	Esc 2001MD ←	PMD02001 ↵	
Disable Direct Access port map ²⁴	Esc 0MD ←	PMD00000 ↵	
View Direct Access port map ²⁴	Esc MD ←	X72 ↵	

Command	ASCII Command (Host to Scaler)	Response (Scaler to Host)	Additional Description
Directories			
NOTES:			
<ul style="list-style-type: none"> • Directory name is a text string that can contain letters A–Z, a–z, digits 1–9, minus signs or hyphens (-), plus sign (+), or colon (:). No blank or space characters are permitted. Names are not case-sensitive. The first character must be an alpha character. • A directory does not truly exist until a file has been copied into that path. • A file and a directory can have the same name. • The current directory is a per-connection setting. It begins at the root for each new IP session. 			
Change or create a directory	<code>[Esc] path/directory/CJ ←</code>	<code>Dir • path/directory/ ←</code>	
Return to root directory	<code>[Esc] /CJ ←</code>	<code>Dir • / ←</code>	
Go up one directory	<code>[Esc] ..CJ ←</code>	<code>Dir • path/directory/ ←</code>	
View current directory	<code>[Esc] CJ ←</code>	<code>path/directory/ ←</code>	
File Commands			
Erase user-supplied Web page or file ^{24,28}	<code>[Esc] filenameEF ←</code>	<code>Del • filename ←</code>	
Erase current directory and its files ^{24,28}	<code>[Esc] /EF ←</code>	<code>Dd1 ←</code>	
Erase current directory and sub-directories ^{24,28}	<code>[Esc] //EF ←</code>	<code>Dd1 ←</code>	
List files in current directory	<code>[Esc] DF ←</code>	Unit response – Telnet:	
List files in current directory and lower levels	<code>[Esc] LF ←</code>	<pre> filenamex • date/time • length ← filenamex • date/time • length ← filenamex • date/time • length ← ... space_remaining • bytes left </pre>	
		Unit response – HEML sample code:	
		<pre> var file=new array (); file [1] = 'filename1, date1, filesize1'; file [2] = 'filename2, date2, filesize2'; ... file [n] = 'filenamen, daten, filesizen'; file [n+1] 'space remaining, bytes left' </pre>	
NOTE: LF has the same response from the unit as DF, except <i>path/directory</i> precede filenames for files from directories below the current directory.			

Command	ASCII Command (Host to Scaler)	Response (Scaler to Host)	Additional Description
Stream Files via Telnet, RS-232, or RS-422			
Load file to user flash memory ^{24,28}	[Esc] +UF <i>filesize, filename</i> ←	Up1 ←	
Load file to user flash memory and set specific time and date ^{24,28}	[Esc] +UF <i>filesize*day-of-week*month*day*year*hour*minute*second, filename</i> ←	Up1 ←	<i>Day-of-week</i> = 1–7 (1 = Sunday, 2 = Monday ...) <i>Month</i> = 1–12 (1 = Jan, 2 = Feb, ...) <i>Day</i> = 1–31 <i>Hour</i> = 0–23 <i>Minute</i> and <i>Second</i> = 0–59
NOTES:			
<ul style="list-style-type: none"> • If there is insufficient space on the unit to store the sent file, the response is Fld ← instead of Up1 ← to denote failure. • You can use this command to update firmware by loading a firmware file with a .S19 extension. If the unit determines that the .s19 file is not intended for the DVS, the Up1 ← response is followed by Fwm ← (firmware mismatch). 			
Retrieve file from user flash memory ^{24,28}	[Esc] <i>filename</i> SF ←	Responds with 4 bytes of file size plus raw, unprocessed data in the file.	
Stream files via Port 80			
Load file to user flash memory	Use a POST on port 80, followed by the delimited data to be written to the flash file memory.		
Retrieve file from user flash memory	Send a page GET on port 80 followed by: Ie. http://192.168.254.254/mypage.html?cmd=WSF	Responds with raw, unprocessed data in file.	
Back Up and Restore Unit Configuration			
Save unit configuration (to file system)	[Esc] 1 * <i>configuration type</i> XF ←	Cfg1 * <i>configuration type</i> ←	For configuration type: Ø = IP configuration (ip.cfg) 1 = Event configuration (event.cfg) 2 = Unit-specific parameters (box.cfg) The files are stored in the directory <i>/nortxe-backup</i> created on the unit by the Save commands.
Restore unit configuration	[Esc] Ø * <i>configuration type</i> XF ←	CfgØ * <i>configuration type</i> ←	

Command	ASCII Command (Host to Scaler)	Response (Scaler to Host)	Additional Description
Event Control			
View event buffer memory ²⁷	<code>[Esc] X104, X105, X106, X107 E ←</code>	<code>X120 ↵</code>	
Write event buffer memory ^{24,27}	<code>[Esc] X104, X105, X106, X108 X107 E ←</code>	<code>Evt X104, X105, X106, X108 ↵</code>	
NOTE: The response to the Write Event command is padded with leading zeros for X104 and X106. X104 = 5 digits; X106 = 10 digits.			
Write string to event buffer memory ^{24,27}	<code>[Esc] string * X104, X105, X106 FE ←</code>	<code>Evt X104, X105, X106, string ↵</code>	
NOTES:			
<ul style="list-style-type: none"> • F must be capitalized to read and write strings to event buffer memory. • The response to the Write String command is padded with leading zeros for X104 and X106. X104 = 5 digits; X106 = 10 digits. • The Write String command expects a string preceded by [Esc]. Strings returned by the device (read or write response) are binary (non-escaped) data. 			
View string from event buffer memory ²⁷	<code>[Esc] X104, X105, X106, X110 FE ←</code>	<code>String</code>	
Start events ^{24,27}	<code>[Esc] 1AE ←</code>	<code>Ego ↵</code>	
Stop events ^{24,27}	<code>[Esc] 0AE ←</code>	<code>Est ↵</code>	
Query the number of events running	<code>[Esc] AE ←</code>	<code>nnnnn ↵</code> In Verbose Mode: <code>Enm nnnnn ↵</code>	Response is a 5-digit number. Telnet text responses: <code>event0 starting loc, length ↵</code> <code>event1 starting loc, length ↵</code>

Using the Signal Processing Products Control Program (SPPCP)

The Windows-based Extron Signal Processing Products Control Program (SPPCP) offers an alternative way to control the DVS 510 Series via an RS-232, RS-422, or Ethernet connection. The graphical user interface includes the same functions as those on the scaler front panel with additional features that are available only through the software.

The control software is compatible with Windows 98, Windows NT, Windows 2000, Windows XP, Windows 7, and higher. Updates can be downloaded from www.extron.com.

NOTE: The control program requires approximately 32 MB of hard disk space.

Installing the Software

The SPPCP software can be installed onto the hard drive of a connected PC either directly from the supplied DVD, or downloaded from the Extron website.

1. On the Extron website opening screen, select the **Download** tab.
2. On the Download Center screen, select **Software** from the sidebar menu on the left or click the **Control Software** button.

The screenshot shows the Extron Electronics website's Download Center. The page has a blue header with the Extron logo and contact information. A navigation bar includes tabs for Products, Training, Applications, Technologies, Company, and Download. The Download tab is selected. The main content area is titled "Download Center" and features a "Global Configurator" section with a description of its features. Below this are three download options: "IP Link Software", "TouchLink Software", and "Control Software". The "Control Software" option is highlighted with a red box. A sidebar on the left contains a "Software" link, also highlighted with a red box, and other categories like "Literature" and "Forms". A search box is located in the top right corner.

Figure 30. Download Center Screen on the Extron Website

3. Locate the Signal Processing Products Control Program file on the list and click the **Download** link at right.



Signal Processing Products Control Program	79-532-01	1.4	Apr. 4, 2013	13.1 MB	 Download (Login required)
Annotator, IN1508, DVS 304 (DVI) series, RGB-DVI 300, RGB-HDMI 300 (A), USP 507, DVS 510 (SA), FOXBOX SR HDMI and the PowerCage FOX SR HDMI					
HDMI					
 Release Notes (Login required)					

Table 1. Download Link for SPPCP Software

4. Enter your login ID. If you do not have one, contact your Extron representative to obtain one.
5. Follow the on-screen instructions to download the program to your computer.

Starting the Software

1. Click **Start > Programs > Extron Electronics > Signal Processing > Signal Processing Products Control** Program. Alternatively, if an SPPCP icon was installed on the desktop, double-click the icon. The Select Connection Type window appears.
2. Select either the **TCP/IP** tab for an IP connection or the **RS232** tab for a serial connection.

- For an IP connection:
 - In the **IP Address/Host Name field**, either enter the IP address of your DVS or select the address from the menu.

NOTE: 192.168.254.254 is the factory-specified default IP address.

- If you are using a port other than the default port 23, enter the port number in the **Telnet Port** field.
- If the unit is password protected, enter the appropriate administrator or user password in the **Password** field.
- For a comm (serial) connection:
 - Select the COM port from the **Port** menu.
 - Select the transmission rate from the **Baud Rate** menu.

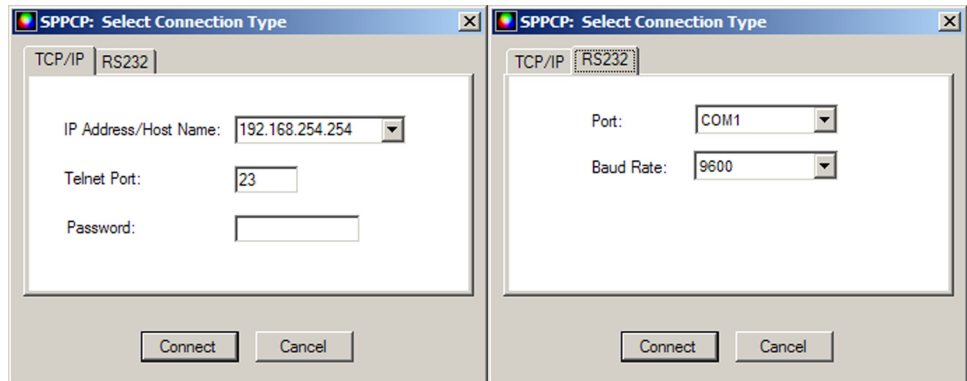

Figure 31. Tabs on the SPPCP: Select Connection Type Window

- Click **Connect**. The Signal Processing Products Control Program main window opens (see figure 32), and the software is ready for operation.

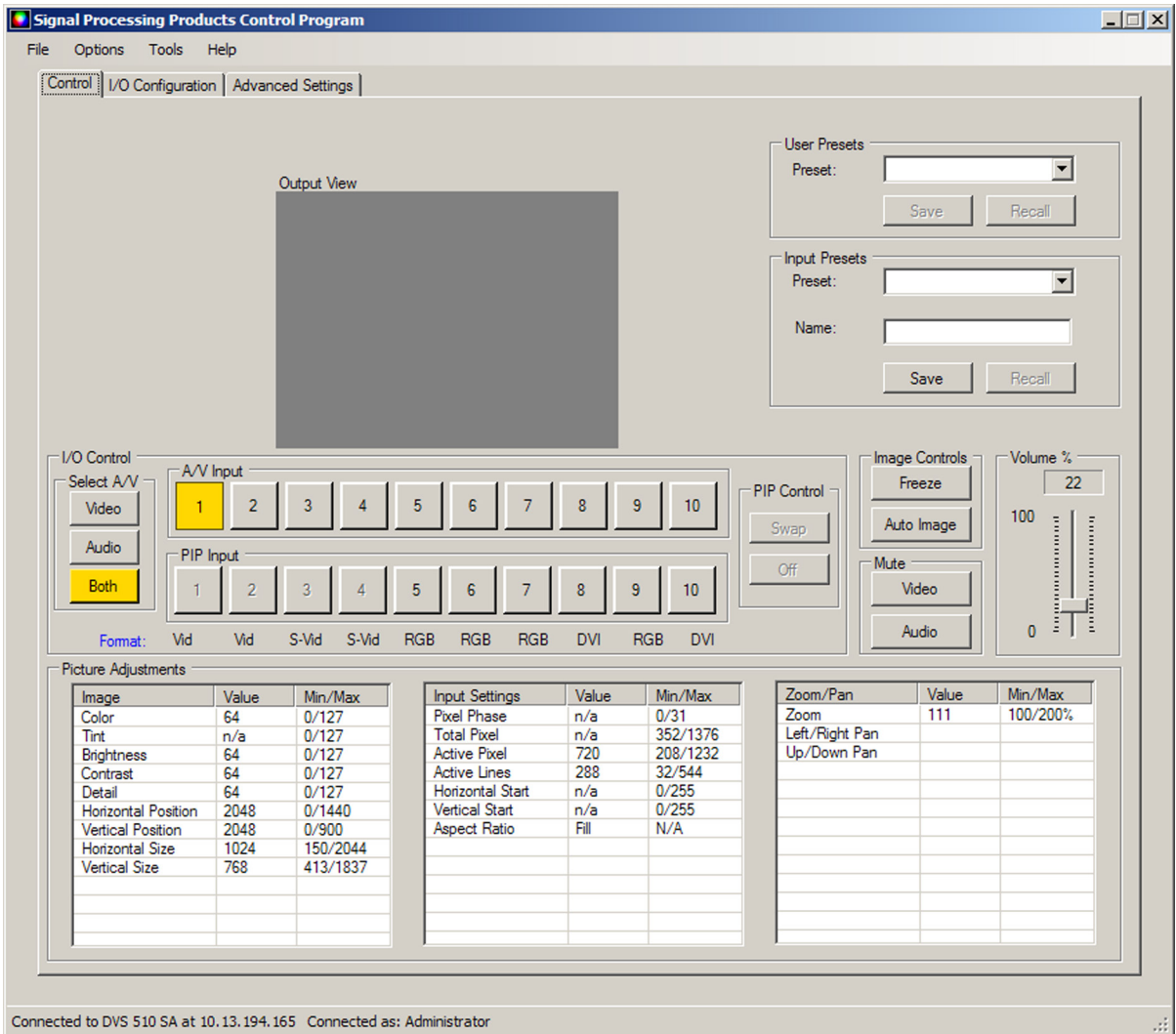

Figure 32. Signal Processing Products Control Program Main Window

Accessing the Help File

For instructions on using the SPPCP software, see the control program help file. To view this file, do either of the following:

- Select **Contents** from the **Help** menu.
- Press the <**F1**> key on your computer keyboard.

Updating the Firmware Using SPPCP

The Firmware Loader utility, accessed through the Signal Processing Products Control Program, provides a way to replace the DVS 510 firmware. The Firmware Loader is available free of charge from the Extron website.

To update the firmware using the Firmware Loader:

1. If necessary, download the Firmware Loader software from www.extron.com as follows:
 - a. On the Extron Web page, select the **Download** tab.
 - b. On the **Download Center** page, select the **Software** link on the left sidebar menu.
 - c. Locate the Firmware Loader and click the **Download** link at the far right.
 - d. Follow the on-screen instructions to download the Firmware Loader program to your computer.
2. From the Extron website, download the latest firmware file and install it on your computer.
 - a. On the Extron Web page, select the **Download** tab.
 - b. On the **Download Center** page, click the **Firmware** link on the left sidebar menu.
 - c. On the list of available firmware files, locate the DVS 510 and click the **Download** link at right.
3. Enter your login ID. If you do not have one, contact your Extron representative to obtain one.
4. Follow the on-screen instructions to download and install the program to your computer.

By default, the firmware file is placed in a folder at:

C:\Program Files\Extron\Firmware\DVS 510 or

C:\Program Files (x86)\Extron\Firmware\DVS 510 (for Windows 7 and higher).

- a. Start the Signal Processing Products Control Program.
- b. From the **Tools** menu, select **Update Firmware**. The SPPCP window minimizes and the **Firmware Loader** window opens.

NOTE: For full instructions about using the Firmware Loader, select **Help** from the **Help** menu on the **Firmware Loader** window or press the <F1> key.

5. On the **Firmware Loader** window, select your DVS 510 name in the **Devices** section, if necessary.
6. Double-click on <double click to set> in the **New Firmware File** column, or select **New Firmware for Selected Devices** from the **File** menu.

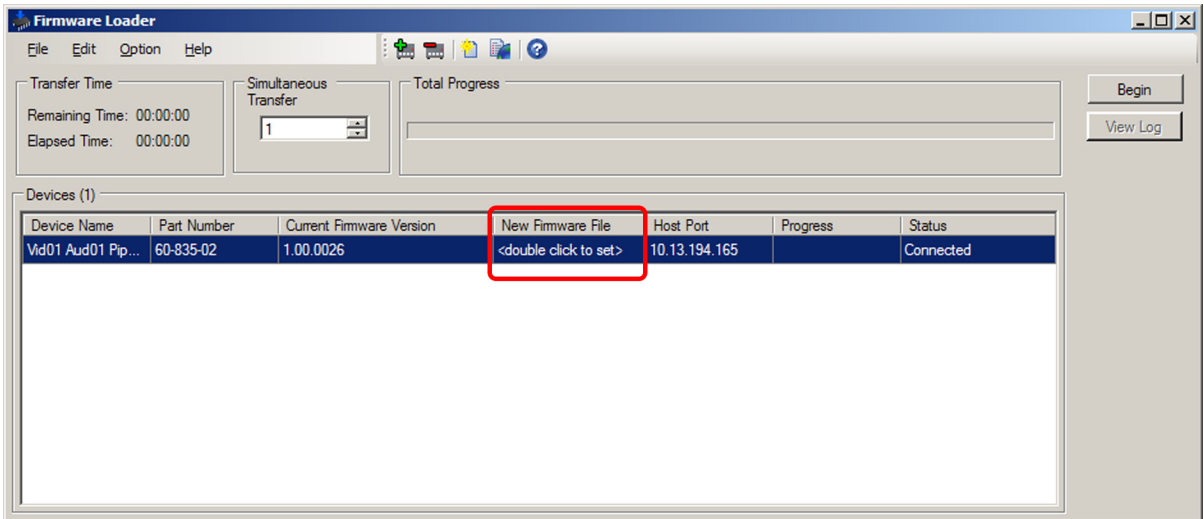

Table 2. Firmware Loader Window

The Choose Firmware File window opens.

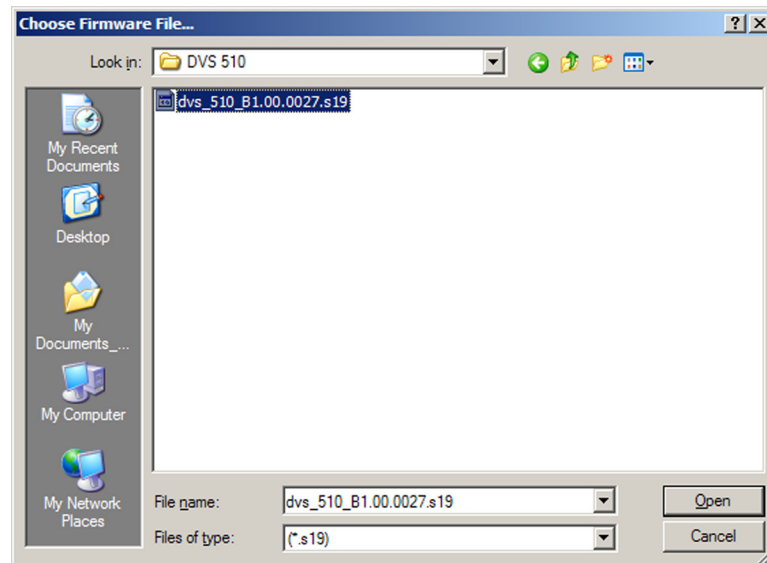

Table 3. Choose Firmware File Window

7. Navigate to the new firmware file, which has a .s19 extension, and double-click it. The Choose Firmware File window closes.

ATTENTION:

- Valid firmware files must have the file extension .s19. A file with any other extension is not a firmware upgrade for this product and could cause the DVS to stop functioning.
- Les fichiers firmware valides doivent contenir l'extension fichier .S19. Les fichiers valides de firmware doivent avoir l'extension fichier .s19 pour les cartes E/S et .eff pour le châssis. Un fichier avec n'importe quelle autre extension n'est pas une mise à jour de firmware pour cet appareil et l'appareil pourrait arrêter de fonctionner.

NOTES:

- The original factory-installed firmware is permanently available on the DVS 510. If the attempted firmware upload fails for any reason, the scaler reverts to the factory-installed firmware.
- When downloaded from the Extron website, the firmware is placed in a folder at C:\Program Files\Extron\Firmware\DVS 510 or C:\Program Files (x86)\Extron\Firmware\DVS 510 (for Windows 7 and higher).

8. Click **Begin**. The following indicators on the **Firmware Loader** window show the progress of the update:
 - The **Transfer Time** panel shows the amounts of remaining and elapsed time for the update.
 - The **Total Progress** panel displays a status bar with **Uploading...** above it.
 - In the **Devices** panel, the Progress column displays an incrementing percentage and the Status column displays **Uploading**.

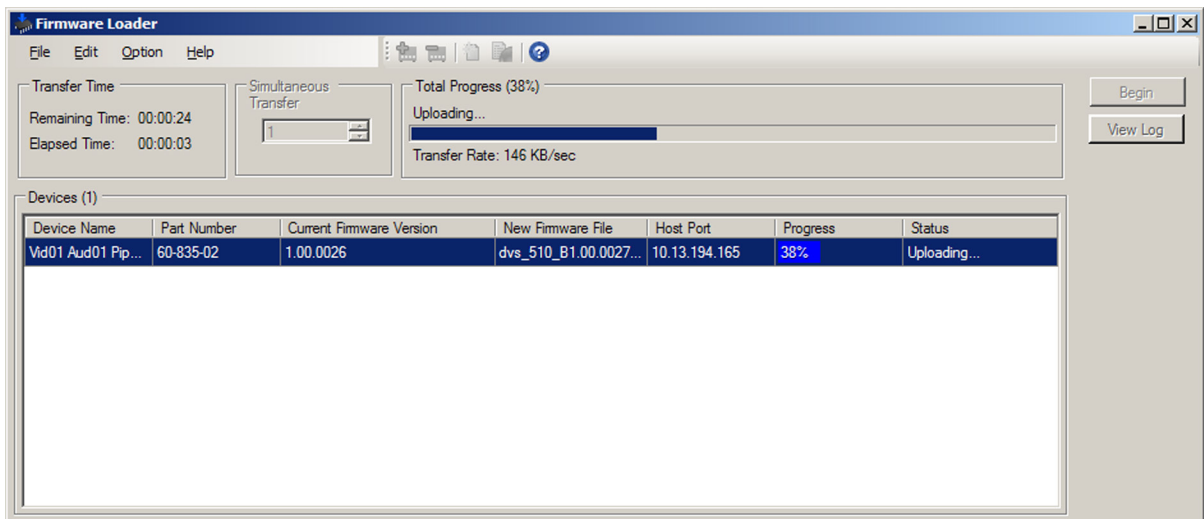

Figure 33. Firmware Upload in Progress

When the upload is complete, the **Remaining Time** panel displays **00.00.00**, the **Progress** column displays **100%**, and **Completed** is displayed above the progress bar and in the **Status** panel.

At this point, the DVS resets itself. The LCD screen on the unit displays **Restarting Please Wait...**, then **Initializing Please Wait...**. When the reset is complete, all the buttons on the front panel blink red, then green, then amber and the LCD screen returns to the default cycle.

9. When the firmware upload and unit reset are complete, close the **Firmware Loader** window. The SPPCP main window is redisplayed.

HTML Configuration and Control

This section provides procedures for accessing and using the DVS 510 embedded Web pages. The following topics are included:

- [Accessing the Web Pages](#)
- [Special Characters](#)
- [System Status Page](#)
- [Configuration Pages](#)
- [File Management Page](#)
- [Control Pages](#)

The DVS can be controlled and operated through its Ethernet port, connected via a LAN or WAN and using a web browser such as Microsoft® Internet Explorer®. The browser displays the DVS web pages, which provide an alternative means of configuring and operating the scaler. These factory-installed web pages are always available and cannot be erased or overwritten.

NOTE: If your Ethernet connection to the scaler is unstable, try turning off the proxy server in your Web browser. To do this in Microsoft Internet Explorer, click **Tools > Internet Options > Connections > LAN Settings**, clear the **Use a proxy server . . .** checkbox, then click **OK**.

Accessing the Web Pages

Access the HTML pages as follows:

1. Start the Web browser program.
2. Click in the browser address field and enter the IP address of your DVS 510.

NOTE: If the local system administrators have not changed the value, use the factory-specified default **192.168.254.254** in this field.

3. If you want the browser to display a page other than the default page (such as a custom page that you have uploaded), enter a slash (/) following the IP address and the name of the page file to open.

NOTES:

- The browser **Address** field should display the IP address in the following format: *nnn.nnn.nnn.nnn/optional_file_name.html*.
- The following characters are invalid or not recommended in file names:
+ ~ , @ = ` [] { } < > ' " ; : | \ and space.

4. Press the <Enter> key. The DVS checks to see if it is password protected.
 - If the scaler is not password protected, the **System Status** Web page opens.
 - If the DVS is password protected, the network password dialog box is displayed.



Figure 34. Example of a Network Password Dialog Box

5. If an administrator or user password is required, enter it in the **Password** field. If desired, select the checkbox to have the system input your password the next time you enter your DVS IP address. Click **OK**.

NOTE: A **User name** entry is not required.

The DVS 510 checks several possibilities, in the following order, and then responds accordingly:

- a. If the address includes a specific file name, such as `10.13.156.10/file_name.html`, the scaler downloads that HTML page.
- b. If there is a file in the DVS memory that is named `index.html`, the scaler downloads `index.html` as the default startup page.
- c. If neither of the above conditions exists, the scaler downloads and displays the factory-installed default startup page, `nortxe_index.html`, which is the file name for the **System Status** page.

Special Characters

The HTML language reserves certain characters for specific functions. The DVS does not accept these characters as part of preset names, the scaler name, passwords, or locally created file names.

Use of the following characters is not recommended:

+ ~ , @ = ` [] { } < > ' " ; : | \ ? and space.

System Status Page

The **System Status** page provides an overall view of the status of the DVS, including firmware version and serial port settings. This page is the default page that the scaler downloads when connected. You can access the **System Status** page from other pages by clicking the **Status** tab.

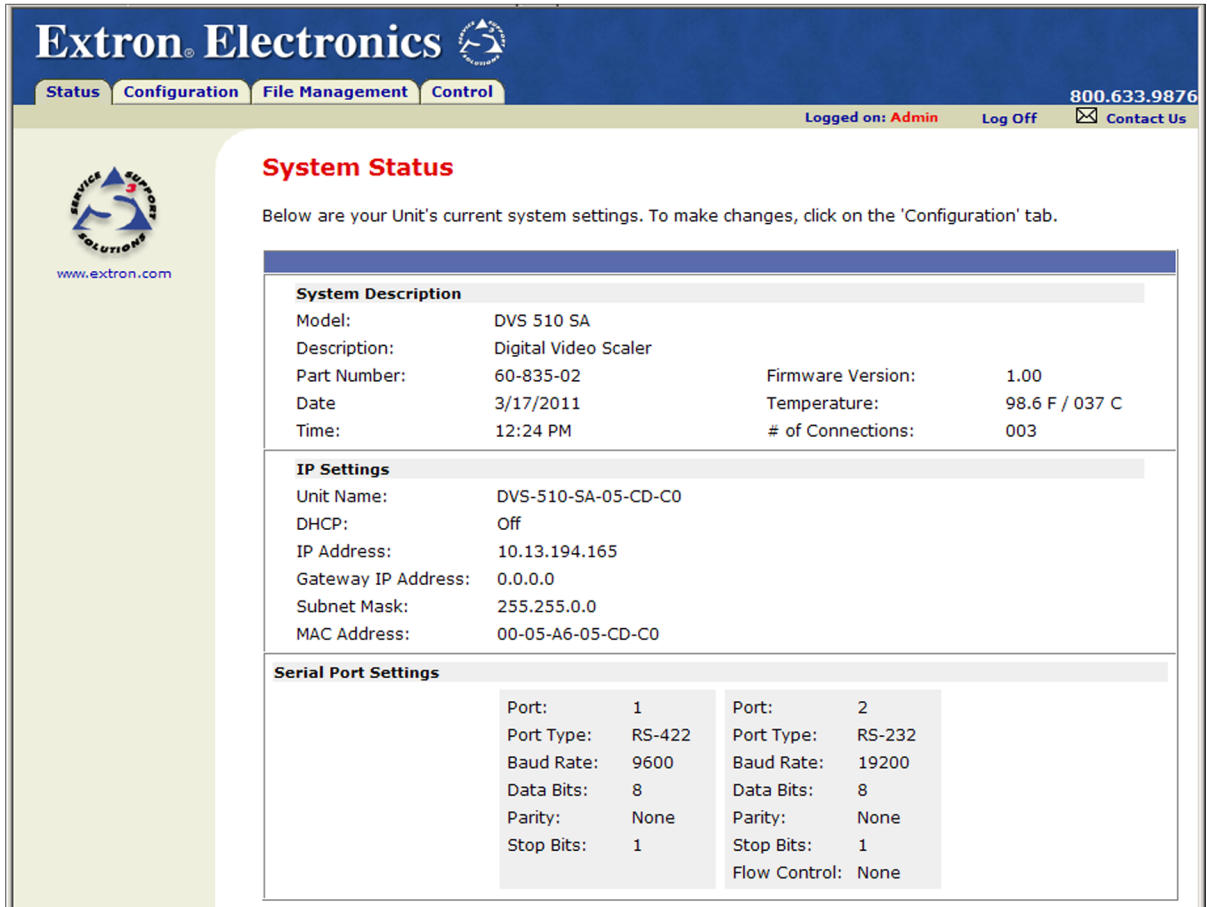

The screenshot displays the Extron Electronics System Status page. The header includes the Extron logo and navigation tabs for Status, Configuration, File Management, and Control. The user is logged in as Admin, and the page number 800.633.9876 is visible. The main content area is titled "System Status" and provides a summary of the unit's current settings. The settings are organized into three sections: System Description, IP Settings, and Serial Port Settings.

System Description			
Model:	DVS 510 SA		
Description:	Digital Video Scaler		
Part Number:	60-835-02	Firmware Version:	1.00
Date:	3/17/2011	Temperature:	98.6 F / 037 C
Time:	12:24 PM	# of Connections:	003

IP Settings	
Unit Name:	DVS-510-SA-05-CD-C0
DHCP:	Off
IP Address:	10.13.194.165
Gateway IP Address:	0.0.0.0
Subnet Mask:	255.255.0.0
MAC Address:	00-05-A6-05-CD-C0

Serial Port Settings			
Port:	1	Port:	2
Port Type:	RS-422	Port Type:	RS-232
Baud Rate:	9600	Baud Rate:	19200
Data Bits:	8	Data Bits:	8
Parity:	None	Parity:	None
Stop Bits:	1	Stop Bits:	1
		Flow Control:	None

Figure 35. System Status Page

The **System Status** Web page updates itself periodically to reflect the latest status of the scaler. If a variable changes, the display shows the change in status the next time it updates. You can also update the page by clicking the **Refresh** button in your browser.

Configuration Pages

The **Configuration** tab accesses four pages that are available only to an administrator. These pages are listed in the left sidebar menu on the **Configuration** tab. The following sections describe the changes you can make from these pages.

System Settings Page

The DVS 510 displays the **System Settings** page when you click the **Configuration** tab. The screen consists of fields in which you can view and edit IP administration and system settings. The **Scaler Settings**, **Passwords**, and **Firmware Upgrade** pages can be accessed by clicking the appropriate link on the left sidebar menu. (See **IP Addressing** on page 114 for basic information about IP addresses and subnetting.)

Extron Electronics

Status Configuration File Management Control

Logged on: Admin Log Off 800.633.9876 Contact Us

System Settings
Scaler Settings
Passwords
Firmware Upgrade

System Settings

Below are your Unit's basic System Settings. Most units will work with the default IP Settings without making any changes. If you require help changing your settings, please refer to the user guide.

IP Settings

Unit Name: DVS-510-SA-05-CD-C0

DHCP: On Off

IP Address: 10.13.194.165

Gateway IP Address: 0.0.0.0

Subnet Mask: 255.255.0.0

MAC Address: 00-05-A6-05-CD-C0

Firmware: 1.00

Model: DVS 510 SA

Part Number: 60-835-02

Submit Cancel

Date/Time Settings

Date: 3/17/2011 Local Date/Time

Time: 1:20 PM

Zone: (GMT-08:00) Pacific Time (US & Canada), Tijuana

Daylight Saving: Off USA Europe Brazil

Submit Cancel

Figure 36. System Settings Page

On password-protected connections, there are two levels of protection: administrator and user. Administrators have full access to all scaling capabilities and editing functions. Users can select inputs, create and recall presets, and view all settings with the exception of passwords.

- Ethernet connection to the scaler can be password protected, either entering SIS commands (see **Remote Configuration and Control**, beginning on page 48) or using the Signal Processing Products Control Program (see the program help file).
- Connection via RS-232 or RS-422 is not password protected.

IP Settings fields

The IP Settings fields let you view and edit settings unique to the Ethernet interface. After editing any of the IP settings, click the **Submit** button at the bottom of this section.

Unit Name field

The **Unit Name** field contains the name used as the “from” information when the DVS e-mails notification of its failed or repaired status. You can change this name field to any valid name, up to 24 alphanumeric characters.

NOTE: The following characters are invalid or not recommended in the name:
+ ~ , @ = [] { } < > ' " ; : | \ and ?.

DHCP radio buttons

The **DHCP On** radio button directs the DVS to ignore any entered IP addresses and to obtain its IP address from a Dynamic Host Configuration Protocol (DHCP) server (if the network is DHCP capable).

The **DHCP Off** radio button turns DHCP off (default).

Contact your local system administrator for this setting.

IP Address field

The **IP Address** field contains the IP address of the connected DVS. This address is encoded in the scaler flash memory.

Valid IP addresses consist of four octets: one-, two-, or three-digit numeric sub-fields separated by periods. Each octet can be numbered from **000** through **255**. Leading zeros, up to three digits total per field, are optional. Values of **256** and above are invalid.

The factory-installed default address is 192.168.254.254, but if this conflicts with other equipment at your installation, you can change the IP address to any valid value.

NOTE: IP address changes can cause conflicts with other equipment. Only local system administrators should change IP addresses.

Gateway IP Address field

The **Gateway IP Address** field identifies the address of the gateway (to the mail server) to be used if the scaler and the mail server are not on the same subnet.

The gateway IP address has the same validity rules as the system IP address (see “IP Address field,” above).

Subnet Mask field

The Subnet Mask field is used to determine whether the scaler is on the same subnet as the mail server when you are using a subnet (see **Subnetting, a Primer**, on page 118, for more information).

The subnet mask address has the same validity rules as the system IP and gateway IP addresses.

MAC Address

The MAC (media access control) address is a unique hardware address by which each individual DVS 510 can be identified. It consists of six pairs of characters separated by hyphens. For all Extron products, the first three character pairs are **00-05-A6**, followed by three more pairs unique to the individual device. The MAC address is hard coded in the scaler and cannot be changed.

Date/Time Settings panel

The fields in the **Date/Time Settings** panel enable you to view and set the date and time parameters.

The screenshot shows the 'Date/Time Settings' panel. It includes a 'Date' field with dropdowns for day (9), month (10), and year (2010), and a 'Local Date/Time' button. The 'Time' field has dropdowns for hour (51) and period (PM). The 'Zone' field is a dropdown menu showing '08:00 Pacific Time (US & Canada), Tijuana'. The 'Daylight Saving' section has radio buttons for 'USA', 'Europe', and 'Brazil', with 'USA' selected. At the bottom are 'Submit' and 'Cancel' buttons. A vertical list of numbers from 1 to 12 is visible on the left side of the panel, likely representing a scrollable list of time zones.

Figure 37. Date/Time Settings Fields

To change the date and time settings:

1. In each **Date** or **Time** field that you want to change, select the desired value from the drop-down menu or key it in the field. (The **Month** drop-down menu is selected in figure 37), or

Click the **Local Date/Time** button to set the date and time to your local settings.

2. From the **Zone** menu, select your time zone. The selection displayed in the **Zone** field identifies the standard time zone and the amount of time, in hours and minutes, that local time varies from the Greenwich Mean Time (GMT) international time reference.
3. If daylight saving time is currently in effect in your area, select the radio button for the area. If daylight saving time is not in effect or is not observed, select **Off**.

NOTE: When daylight savings time is enabled, the scaler updates its internal clock between standard time and daylight savings time in the spring and fall on the date that the time change occurs in the United States of America and parts of Europe and Brazil. When daylight savings time is turned off, the scaler does not adjust its time reference.

4. Click the **Submit** button at the bottom of the **Date/Time Settings** panel to implement your selections.

Scaler Settings Page

The **Scaler Settings** page simulates elements of the DVS 510 front panel menu system and also allows you to set video input signals (for inputs 5, 6, 7, and 9 only), configure the output, and remotely select advanced configuration options.

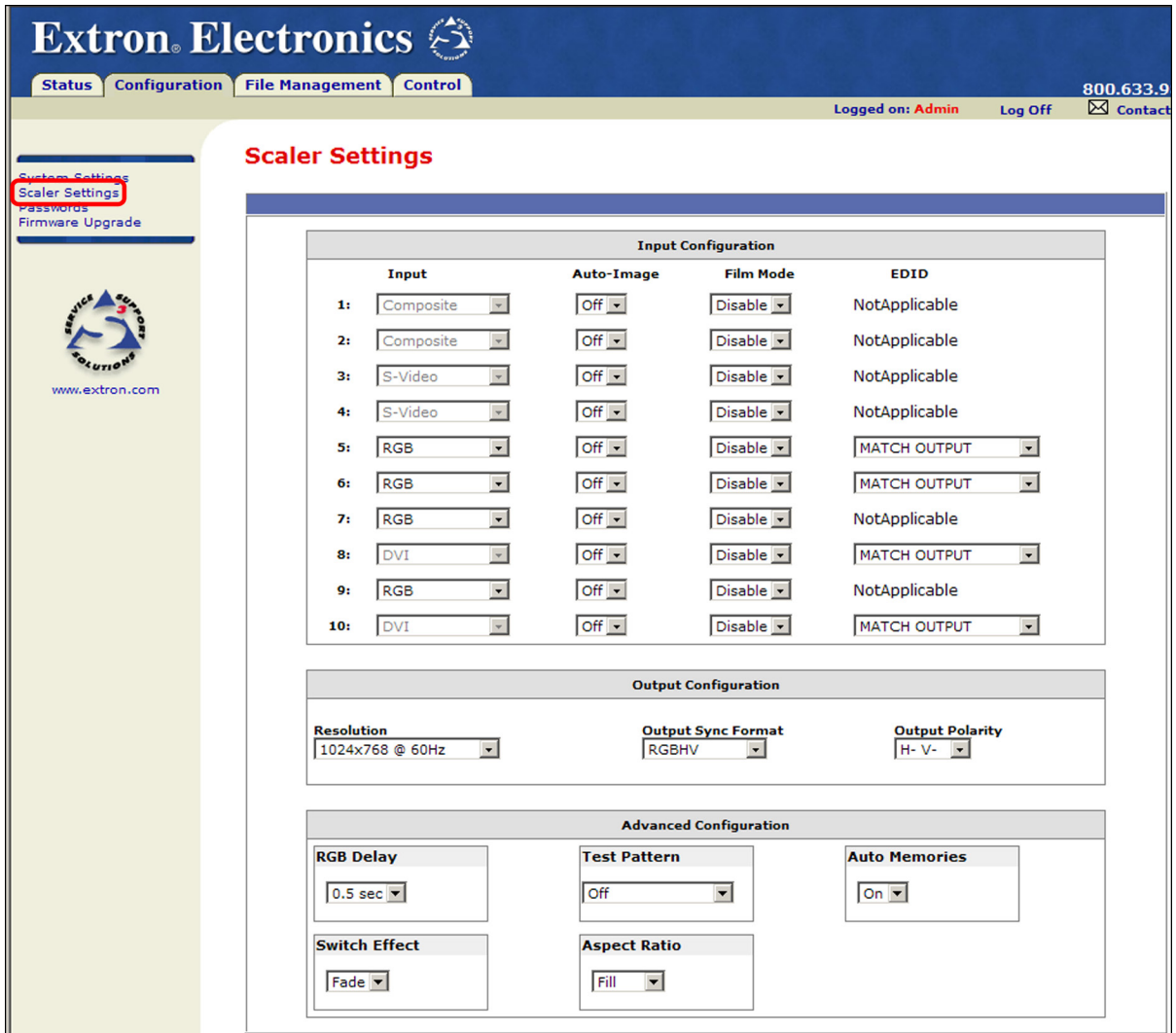

Input Configuration			
Input	Auto-Image	Film Mode	EDID
1: Composite	Off	Disable	NotApplicable
2: Composite	Off	Disable	NotApplicable
3: S-Video	Off	Disable	NotApplicable
4: S-Video	Off	Disable	NotApplicable
5: RGB	Off	Disable	MATCH OUTPUT
6: RGB	Off	Disable	MATCH OUTPUT
7: RGB	Off	Disable	NotApplicable
8: DVI	Off	Disable	MATCH OUTPUT
9: RGB	Off	Disable	NotApplicable
10: DVI	Off	Disable	MATCH OUTPUT

Output Configuration		
Resolution 1024x768 @ 60Hz	Output Sync Format RGBHV	Output Polarity H- V-

Advanced Configuration		
RGB Delay 0.5 sec	Test Pattern Off	Auto Memories On
Switch Effect Fade	Aspect Ratio Fill	

Figure 38. Scaler Settings Page

Input Configuration panel

The **Input Configuration** panel contains drop-down menus that enable you to select various parameters for all or some of the inputs. The following menus are provided:

- **Input** — Select the analog signal type (RGB, YUVp/HDTV, RGBcvs, or YUVi) for inputs 5, 6, 7, and 9.
- **Auto-Image** — Enable (**On**) or disable (**Off**) Auto-Image for each input. When Auto-Image is enabled, each time an input is selected the DVS performs an image adjustment. This consists of measuring where the active area starts and stops and adjusting input sampling accordingly so that the image fills the window.
- **Film Mode** — Select **Enable** or **Disable** for film mode detection for each input.

- **EDID** — Select an EDID (resolution and refresh rate) for inputs 5, 6, 8, and 10. You can select Match Output, which applies the EDID of the output to the selected input, or select one of the following EDIDs:

640x480 @ 50 Hz	1024x1024 @ 60 Hz	1360x768 @ 75 Hz	1680x1050 @ 60 Hz	1080i @ 60 Hz
640x480 @ 60 Hz	1024x1024 @ 75 Hz	1365x768 @ 50 Hz	1600x1200 @ 50 Hz	1080p @ 23.98 Hz
640x480 @ 75 Hz	1280x768 @ 50 Hz	1365x768 @ 60 Hz	1600x1200 @ 60 Hz	1080p @ 24 Hz
800x600 @ 50 Hz	1280x768 @ 60 Hz	1365x768 @ 75 Hz	1920x1200 @ 50 Hz	1080p @ 25 Hz
800x600 @ 60 Hz	1280x768 @ 75 Hz	1366x768 @ 50 Hz	1920x1200 @ 60 Hz	1080p @ 29.97 Hz
800x600 @ 75 Hz	1280x800 @ 50 Hz	1366x768 @ 60 Hz	480p @ 59.94 Hz	1080p @ 30 Hz
852x480 @ 50 Hz	1280x800 @ 60 Hz	1366x768 @ 75 Hz	480p @ 60 Hz	1080p @ 50 Hz
852x480 @ 60 Hz	1280x800 @ 75 Hz	1365x1024 @ 50 Hz	576p @ 50 Hz	1080p @ 59.94 Hz
852x480 @ 75 Hz	1280x1024 @ 50 Hz	1365x1024 @ 60 Hz	720p @ 25 Hz	1080p @ 60 Hz
1024x768 @ 50 Hz	1280x1024 @ 60 Hz	1365x1024 @ 75 Hz	720p @ 29.97 Hz	2040x1080 @ 23.98 Hz
1024x768 @ 60 Hz*	1280x1024 @ 75 Hz	1440x900 @ 50 Hz	720p @ 30 Hz	2040x1080 @ 24 Hz
1024x768 @ 75 Hz	1360x765 @ 50 Hz	1440x900 @ 60 Hz	720p @ 50 Hz	2040x1080 @ 25 Hz
1024x852 @ 50 Hz	1360x765 @ 60 Hz	1440x900 @ 75 Hz	720p @ 59.94 Hz	2040x1080 @ 29.97 Hz
1024x852 @ 60 Hz	1360x765 @ 75 Hz	1400x1050 @ 50 Hz	720p @ 60 Hz	2040x1080 @ 30 Hz
1024x852 @ 75 Hz	1360x768 @ 50 Hz	1400x1050 @ 60 Hz	1080i @ 50 Hz	2040x1080 @ 50 Hz
1024x1024 @ 50 Hz	1360x768 @ 60 Hz	1680x1050 @ 50 Hz	1080i @ 59.94 Hz	2040x1080 @ 59.94 Hz
*Default				2040x1080 @ 60 Hz

Output Configuration panel

In this panel, you can select output parameters from the following drop-down menus:

- **Resolution** — Select the resolution and refresh rate for the current output. Note that resolutions on this menu are linked to refresh rates as shown in the table above.
- **Output Sync Format** — Select the output signal type required by the display device. Available selections are RGBHV (default), RGBS, RGsB, YUV Bi-Level, and YUV Tri-Level.
- **Output Polarity** — Select the combination of horizontal and vertical sync signal polarities. Available selections are H- V- (default), H- V+, H+ V-, and H+ V+.

Advanced Configuration panel

In this panel, you can perform additional configuration by making selections from the following menus:

- **RGB Delay** — Select a period of delay before a new image is displayed on the screen, allowing the display device to adjust to the new sync timing. Options are 0.0 through 5.0 seconds in 0.1-second increments.
- **Test Pattern** — Select a test pattern to assist you in adjusting the display device for color, convergence, focus, resolution, contrast, grayscale, and aspect ratio. **Figure 39** on the next page shows the test patterns that are available.

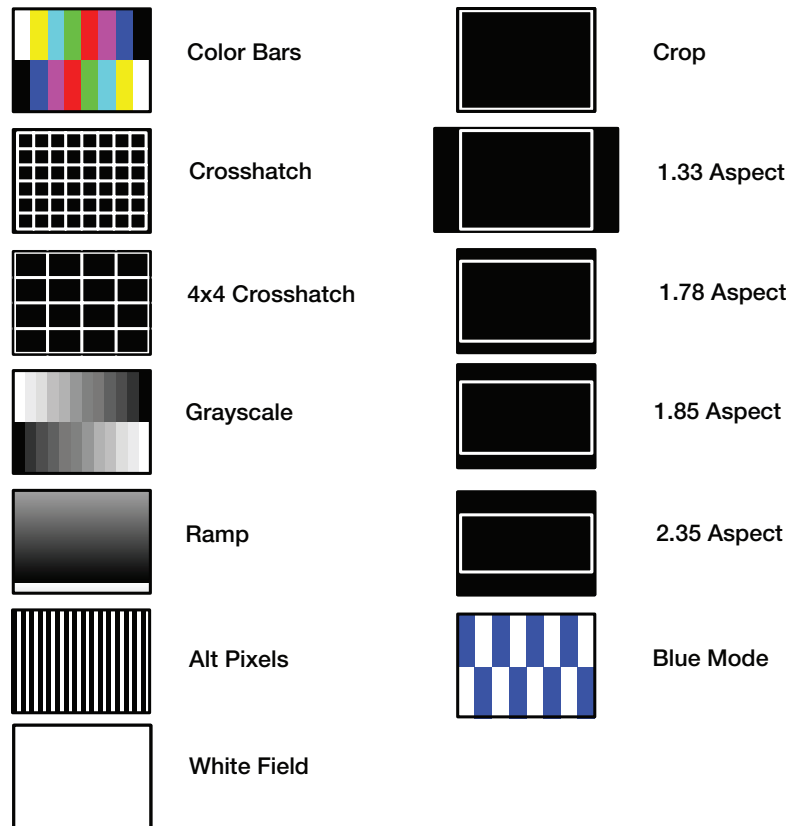

Figure 39. Test Patterns on the DVS 510

The default is **Off** (no test pattern). (See [Test Pattern submenu](#) on page 32 for more information on using test patterns.)

- **Auto Memories** — Select **On** or **Off** to enable or disable auto memories. When auto memories are activated, the DVS stores size, position, and picture settings based on the incoming signal from the connected input. When the same input signal is detected again, these image settings are recalled from memory and applied.
- **Switch Effect** — Select the effect that is displayed when inputs are switched. **Cut** immediately replaces the image from the current input with the image from the new input. **Fade** causes the current input to fade to black while the new input fades in (default).
- **Aspect Ratio** — Select **Fill** (the input signal at each rate fills the entire output raster), or **Follow** (the input signal at each rate is displayed with its native aspect ratio [default setting]). (See [Aspect Ratio submenu](#) on page 31 for more information about these fill modes.)

Passwords Page

Access the **Passwords** page by clicking the **Passwords** link on the sidebar menu on the System Settings page.

Extron Electronics

Status Configuration File Management Control

800.633.9876

Logged on: Admin Log Off Contact Us

System Settings
Scaler Settings
Passwords
Firmware Upgrade

Service Support Solutions
www.extron.com

Passwords

To update the Administration Password, enter the desired password, repeat the entry, and press 'Submit'. To update the User Password, enter the desired password, repeat the entry, and press 'Submit'. To clear a password, enter a single space, repeat the entry, and press 'Submit'. Minimum password length is 4 characters. Maximum password length is 12 characters. Passwords are case sensitive and special characters are not allowed.

Passwords

Administrator Password: Re-enter Admin Password:

User Password: Re-enter User Password:

Submit Cancel

Figure 40. Passwords Page

Setting a password

The fields on the Passwords page are used to enter and verify administrator and user passwords. Passwords are case-sensitive and are limited to 12 upper- and lowercase alphanumeric characters.

1. Enter the new administrator password in the **Administrator Password** field.
2. In the **Re-enter Admin Password** field, enter the same password to confirm it.
3. If you want to assign a user password, enter it in the **User Password** and **Re-enter User Password** fields.

NOTE: An administrator password must be created before a user password can be assigned.

4. Click the **Submit** button to set the passwords.

Characters in the password fields are masked by four bullets (••••). If you do not want to password-protect an access level, leave the **Password** and the **Re-enter Password** fields blank.

Removing passwords

To clear an existing password so that no password is required, delete the bullets in the **Password** and **Re-enter Password** fields and enter a space in each field, then click the **Submit** button at the bottom of the page.

Firmware Upgrade Page

The **Firmware Upgrade** page lets you update the firmware that is loaded on the DVS control board without taking the scaler out of service. Access the **Firmware Upgrade** page by clicking the **Firmware Upgrade** link on the **System Settings** page.

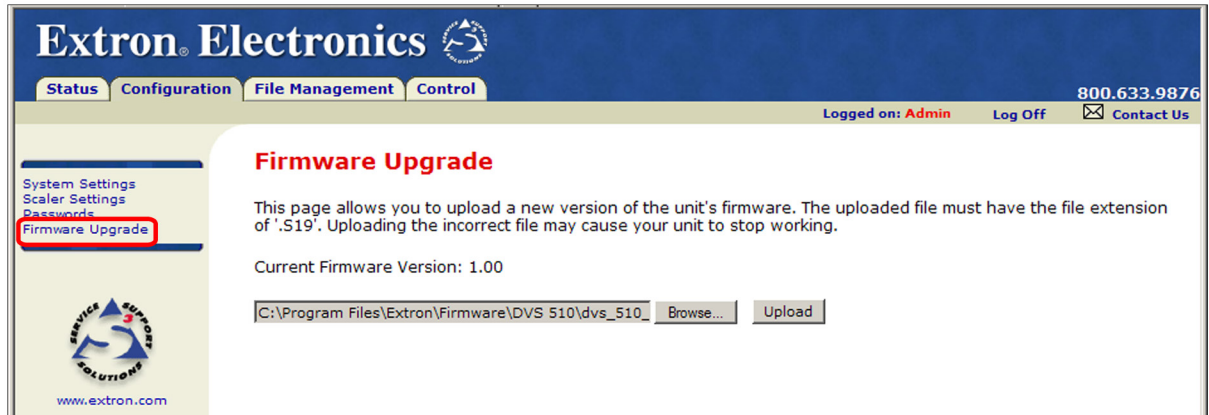

Figure 41. Firmware Upgrade Page

To update firmware using the **Firmware Upgrade** page:

1. From the Extron website, download the latest firmware file and install it on your computer.
 - a. On the Extron Web page, select the **Download** tab.
 - b. On the **Download Center** page, click the **Firmware** link on the left sidebar menu.
 - c. On the list of available firmware files, locate the DVS 510 and click the **Download** link at right.
 - d. Enter your login ID. If you do not have one, contact your Extron representative to obtain one.
 - e. Follow the on-screen instructions to download the program to your computer.

By default, the firmware file is placed in a folder at:
C:\Program Files\Extron\Firmware\DVS 510 or
C:\Program Files (x86)\Extron\Firmware\DVS 510 (for Windows 7 and higher).
2. Access the DVS 510 web pages.
3. Select the **Configuration** tab.
4. On the **Configuration** page, click the **Firmware Upgrade** link on the left sidebar menu.

5. Click the **Browse** button. A Choose File to Upload window opens.

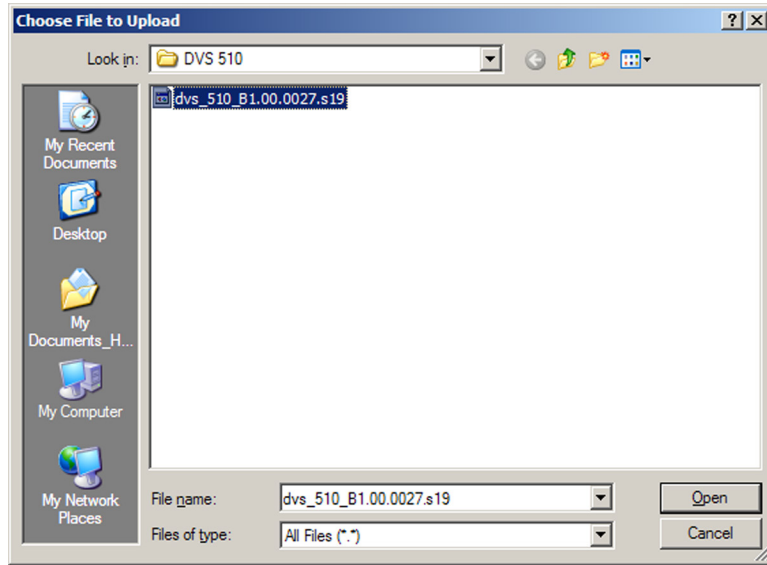

Figure 42. Choose File to Upload Window with a Firmware File Selected

6. Navigate to the folder where you saved the firmware upgrade file and double-click on the firmware file name (it must have a .s19 extension). The **Choose Firmware File** window closes, and the path to the new firmware file is displayed in the **Current Firmware Version *n.nn*** field on the **Firmware Upgrade** page.

ATTENTION:

- Valid firmware files must have the file extension .s19. A file with any other extension is not a firmware upgrade for this product and could cause the DVS to stop functioning.
- Les fichiers firmware valides doivent contenir l'extension fichier .S19. Les fichiers valides de firmware doivent avoir l'extension fichier .s19 pour les cartes E/S et .eff pour le châssis. Un fichier avec n'importe quelle autre extension n'est pas une mise à jour de firmware pour cet appareil et l'appareil pourrait arrêter de fonctionner.

NOTES:

- The original factory-installed firmware is permanently available on the DVS 510. If the attempted firmware upload fails for any reason, the scaler reverts to the factory-installed firmware.
- When downloaded from the Extron website, the firmware is placed in a folder at C:\Program Files\Extron\Firmware\DVS 510 or C:\Program Files (x86)\Extron\Firmware\DVS 510 (for Windows 7 and higher).

7. Click **Upload**. While the new firmware is being uploaded, the **Upload** button changes to **Uploading...** and the LCD window on the DVS front panel displays **Firmware Uploading**. When the firmware upload is completed, the button changes back to **Upload**. (The uploading may take a few minutes.)

At this point, the DVS resets itself. The LCD screen on the unit displays **Restarting Please Wait...**, then **Initializing Please Wait...**. When the reset is complete, all the buttons on the front panel blink red, then green, then amber. The LCD screen returns to the default cycle.

File Management Page

The **File Management** page is a useful tool that allows you to use and upload existing and custom web pages. Custom pages can be developed using a third-party web page development program such as Microsoft Office FrontPage or Adobe® Dreamweaver®. File management also allows you to remove unnecessary or outdated files when they are no longer needed.

To access this page, click the **File Management** tab.

Extron Electronics

Status Configuration **File Management** Control

800.633.9876
Logged on: Admin Log Off Contact Us

File Management

File Management allows you to upload and delete files from the server. File names must contain valid alpha-numeric characters. Special characters are not allowed in the file name. To add a Directory, enter the directory name in the field provided and click 'Add Dir'. Then 'Browse' and upload a file to the new directory. To delete a file or directory, click on the 'Delete' button next to the file or directory name. The 'Delete All' button deletes all contents of the current directory. If the current directory is 'ROOT', all files on the system will be deleted.

Dir: / Add Dir Browse... Upload File

Filter by File Extension: All Files: 5 Bytes Left: 925,952

Files	Date	File size	Delete All
JPG			
edit_menu.jpg	Fri 12 May 2006 16:21:04 GMT	48,986	Delete
edit_notifiers_window.jpg	Fri 12 May 2006 16:22:13 GMT	58,461	Delete
enter_info_for_inaccessible.jpg	Fri 12 May 2006 16:23:35 GMT	45,157	Delete
event_messages_on_screen.jpg	Fri 12 May 2006 16:24:39 GMT	199,210	Delete
group_single_device_screen.jpg	Fri 12 May 2006 16:20:31 GMT	23,489	Delete

Figure 43. File Management Page

NOTE: The files listed in figure 43 are shown for example only and may not be present on your scaler.

Uploading Files

Files to be uploaded to the DVS must contain only valid alphanumeric characters and underscores.

NOTE: The following characters are invalid or not recommended in file names:
+ ~ , @ = ` [] { } < > ' " ; : \ and space.

To upload files from the server, follow these steps:

1. Click the **Browse** button to the right of the file name field.
2. Browse to locate the file that you want to upload, and double-click on it. The file name and directory path are displayed in the file name field on the **File Management** page.
3. Click the **Upload File** button. The selected file name appears in the **Files** column on the **File Management** page. (Files are listed separately under headings of their extensions.)

NOTE: If you want one of the pages that you create and upload to be the default startup page, name that file "index.html."

Adding a Directory

To add a directory or folder to the DVS file system:

1. Enter the directory name in the **Dir:** field, following the slash (/).
2. Click the **Add Dir** button.
3. With the directory name displayed, perform the **uploading files** procedure described on the previous page to add a file to the directory. The directory name appears at the top of the **Files** column, preceded by a slash (/).

To add more files to the directory, click the directory name to open it, then perform the uploading files procedure. To exit the directory, click (**root**) or (**back**).

Other File Management Activities

You can also perform the following tasks on the **File Management** page:

- **Open a file** — Click on the name of the file in the **Files** column.
- **Delete a file** — Click the **Delete** button at the right end of the line that contains the file you want to remove.
- **Delete all files** — Click the **Delete All** button.
- **Display files by file extension** — The **Filter by File Extension** menu lists the extensions of the files that have been uploaded to the DVS. This menu lets you choose to display only files with the extension you select. Select **All** to display all uploaded files.

Control Pages

The **Control** tab provides access to unique DVS 510 features such as input selection, audio configuration, saving and recalling memory (user) and input presets, and picture-in-picture (PIP) setup.

The following sections describe the functions on the **Control** tab, accessed by clicking the links on the left sidebar menu.

User Control Page

The **User Control** page simulates elements of the DVS 510 front panel and also includes other features such as picture control, mute and freeze options, Auto-Image, film mode detection, aspect ratio selection, and front panel lockout (executive mode).

The screenshot displays the Extron Electronics User Control interface for the DVS 510 SA. The page is organized into several functional sections:

- Header:** Extron Electronics logo and navigation tabs (Status, Configuration, File Management, Control). User information: Logged on: Admin, Log Off, Contact Us, 800.633.9876.
- Left Sidebar:** 'User Control' link (highlighted with a red box), 'Presets', 'PIP Setup', and 'Service Solutions' logo with the website 'www.extron.com'.
- Main Control Area:**
 - Input Selection:** A grid of buttons numbered 1 through 10, with button 10 selected.
 - Signal Type:** Radio buttons for 'Both' (selected), 'Video', and 'Audio'.
 - Executive Mode:** Radio buttons for 'Mode 1 (Full)', 'Mode 2 (Partial)', and 'Disable' (selected).
 - Auto-Image:** Buttons for 'EXECUTE', 'FILL', and 'FOLLOW'.
 - Video:** 'MUTE' and 'FREEZE' buttons.
 - Power Amp Limiter:** 'OFF' (selected) and 'ON' buttons.
 - Audio:**
 - 'MUTE' and 'DELAY' buttons.
 - 'Volume' control: 22, with '-' and '+' buttons.
 - 'Gain/Attenuation' control: + 0 dB, with '-' and '+' buttons.
 - 'Bass' control: - 0.0 dB, with '-' and '+' buttons.
 - 'Treble' control: - 0.0 dB, with '-' and '+' buttons.
 - 'Output Format': 'MONO' and 'STEREO' (selected) buttons.
 - 'Audio Start Up Limiter': 100, with '-' and '+' buttons.
 - Picture Control:**
 - Horizontal Shift: 2048, with '-' and '+' buttons.
 - Vertical Shift: 2048, with '-' and '+' buttons.
 - Horizontal Size: 1024, with '-' and '+' buttons.
 - Vertical Size: 0768, with '-' and '+' buttons.
 - Pan: 'U', 'L', 'R', and 'D' directional buttons.
 - Color: with '-' and '+' buttons.
 - Tint: with '-' and '+' buttons.
 - Brightness: 064, with '-' and '+' buttons.
 - Contrast: 064, with '-' and '+' buttons.
 - Detail Filter: 064, with '-' and '+' buttons.
 - Zoom: 100, with '-' and '+' buttons.
 - Input Sampling:**
 - Horizontal Start: with '-' and '+' buttons.
 - Vertical Start: with '-' and '+' buttons.
 - Pixel Phase: with '-' and '+' buttons.
 - Total Pixels: with '-' and '+' buttons.
 - Active Pixels: 1920, with '-' and '+' buttons.
 - Active Lines: 1080, with '-' and '+' buttons.

Figure 44. User Control Page

On the **User Control** page, you can perform the following functions:

Selecting an input and signal type

Before selecting an input, you must select video, audio, or both for output. To select an input:

1. In the **Signal Type** panel, select the radio button for the type of signal you will be sending to the output:
 - **Both** — Both audio and video will come from the same input (default).
 - **Video** — Only the video signal will come from the new input.
 - **Audio** — Only the audio signal will come from the new input.
2. In the **Input Selection** panel, click the desired input button.

The button on the screen is highlighted and its equivalent button on the front panel lights as follows, depending on your signal type selection:

- If you selected **Both** as the signal type, the input button on the screen is highlighted and the equivalent front panel button lights amber.
 - If you selected either **Audio** or **Video** (audio or video breakaway), the following occurs:
 - **Video** — The screen input button is highlighted and the equivalent front panel button lights green.
 - **Audio** — The screen input button is highlighted and blinks (the blinking continues until the audio is switched to a different input). The equivalent button on the front panel lights red.
3. If using audio or video breakaway, repeat steps 1 and 2 for the remaining signal type.

Configuring the audio

In the **Audio** panel, you can configure the audio signal by adjusting the following controls:

- **Mute** — Click this button to mute and unmute the audio. When audio is muted, this button is highlighted. The default is unmuted.
- **Delay** — Click this button to delay the audio to match the video delay. When audio delay is enabled, this button is highlighted (the default).
- **Volume** — Raise or lower the volume level by selecting a volume step (**1** through **100**) from the drop-down menu or by clicking the **+** or **-** buttons to increase or decrease the step number.
- **Gain/Attenuation** — Set the gain level by selecting a **+** number from the drop-down menu or the attenuation level by selecting a **-** number. Alternatively, click the **+** and **-** buttons to increase or decrease the gain or attenuation level. The default is **0**.
- **Bass** — Increase or decrease the bass by selecting a level (**-12** through **+12**) from the drop-down menu or by clicking the **+** or **-** buttons to increase or decrease the level. The default is **0**.
- **Treble** — Increase or decrease the treble by selecting a level (**-12** through **+12**) from the drop-down menu or by clicking the **+** or **-** buttons to increase or decrease the level. The default is **0**.
- **Output format** — Click the **Mono** (for dual mono) or **Stereo** button to select the output type. The selected button is highlighted. The default is **Stereo**.
- **Audio Start Up Limiter** — (DVS 510 SA only) From the drop-down menu, select the maximum volume level that the limiter will permit when the DVS is powered up. You can select volume step **1** through **100**.

Picture Control

From the **User Control** screen, you can adjust the picture controls listed below.

NOTE: These controls are not available when the DVS is in PIP mode. To adjust picture controls for the PIP window, click **PIP Setup** on the left sidebar menu to use the **PIP Setup** screen.

To adjust the picture controls in this section (except for **Pan**), either click the **+** or **-** button to increase or decrease the value in the text field, or key in a value.

- **Horizontal Shift** — Move the image to the right or left on the display. The value in the text box is the distance in pixels of the left edge of the image from the left edge of the window. The range is dependent on the output; the default is **0** plus or minus the output rate. (This is the same as horizontal positioning or centering.)
- **Vertical Shift** — Move the image up or down on the display. The value in the text box is the distance in lines of the top edge of the image from the top edge of the display. The range is dependent on the output; the default is **0** plus or minus the output rate. (This is the same as vertical positioning or centering.)
- **Horizontal Size** — Stretch or shrink the image horizontally. The value in the text box is the width of the image in pixels. The range is dependent on the output rate.
- **Vertical Size** — Stretch or shrink the image vertically. The value in the text box is the height of the image in lines. The range is dependent on the output rate.
- **Color** — Adjust the intensity of the colors in the image. (At the lowest adjustment, all colors appear as shades of gray.) The range is **000** through **127**; the default is **064**.
- **Tint** — Change the appearance of the colors in the selected window. The range is **000** through **127**, the default is **064**.
- **Brightness** — Set the black level of the input. The range is **000** through **127**; the default is **064**.
- **Contrast** — Increase or decrease the range of light and dark values in the image. The range is **000** through **127**; the default is **064**.
- **Detail Filter** — Adjust the sharpness of the image. The range is **000** through **127**; the default is **064**.
- **Zoom** — Increase or decrease the size of the image while keeping the aspect ratio constant. The range is dependent on the output rate.
- **Pan** — Click the **L** or **R** button to move the focus on the image left or right. Click the **U** or **D** button to pan up or down. Pan is available only if Zoom is set to greater than 100%.

Input Sampling

The input sampling controls can be adjusted in the same manner as the picture controls: either click the **+** or **-** button to increase or decrease the value in the text field, or key in a value.

NOTE: These controls are not available when the DVS is in PIP mode. To adjust picture controls for the PIP window, click **PIP Setup** on the left sidebar menu to use the **PIP Setup** screen.

- **Horizontal Start:** Specify the distance in pixels from the left edge of the total video display area of the selected input to the left edge of its active area. The default is **128**.
- **Vertical Start:** Specify the distance in pixels from the top edge of the total video display area of the selected input to the top edge of its active area. The default is **128**.

- **Pixel Phase (RGB and YUVp/HDTV inputs only)** — Adjust the point at which pixels are sampled for the selected input. The range is 1 through 31, the default is 16.
- **Total Pixels (RGB and YUVp/HDTV inputs only)** — Increase or decrease the width in pixels of the total line of video. The default is the auto-sensed value. The range is ± 512 from the auto-sensed value.
- **Active Pixels** — Increase or decrease the width in pixels of the active video area of the selected input. The default is the auto-sensed value. The range is ± 512 from the auto-sensed value.
- **Active Lines** — Increase or decrease the height in lines of the active video area of the selected input. The default is the auto-sensed value. The range is ± 512 from the auto-sensed value.

Memory/Input Presets Page

On the Presets page, you can save and recall user (memory) and input presets.

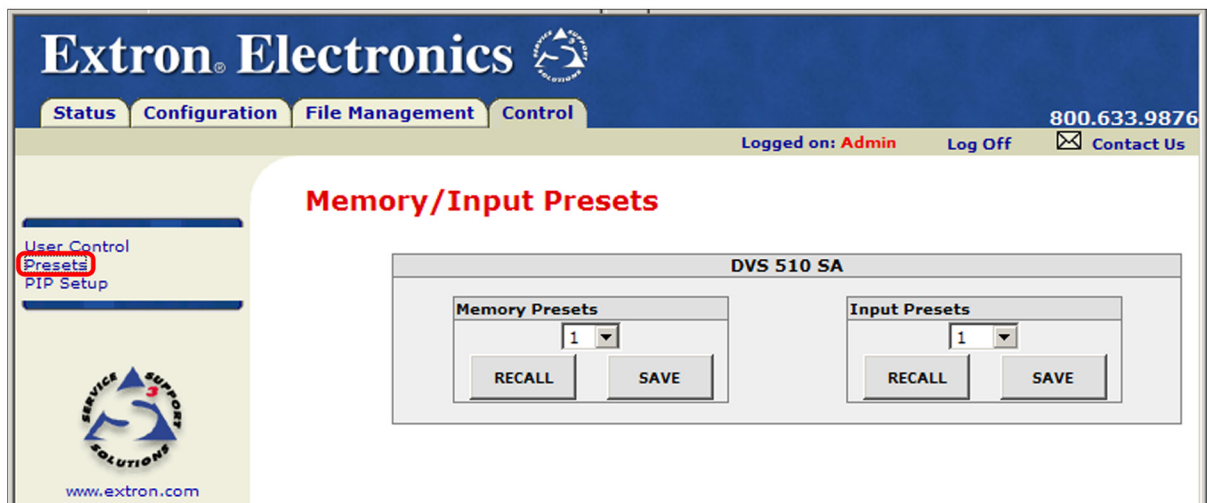

Figure 45. Memory/Input Presets Page

User (memory) presets

User presets save the current set of image parameters for the currently selected input. Each input has 16 available user presets to which you can save settings. You can subsequently recall any of the saved presets to replace the current configuration. The following parameters are saved in a user preset:

- Color
- Tint
- Contrast
- Brightness
- Horizontal position
- Vertical position
- Horizontal size
- Vertical size
- Detail
- Pan
- Zoom

To create a user preset:

1. Click the **User Control** link on the left sidebar menu to display the **User Control** page.
2. In the **Input Selection** panel, click the button for the input for which you want to create the preset.
3. Make any desired changes to the picture and input sampling controls and other attributes for your chosen input.
4. Click the **Presets** link on the left sidebar menu to display the **Presets** page.

5. From the **Memory Presets** drop-down menu, select a number for the preset you are creating.
6. Click the **Save** button.

To recall a saved user preset:

1. From the **Memory Presets** drop-down menu, select a preset number.
2. Click the **Recall** button. The preset is applied to the current input.

Input presets

The DVS 510 Series has 128 input preset slots, which can save signal type, input configuration settings, and picture control settings for any of the inputs. These presets can be saved and recalled using the Windows-based control software (see the *Signal Processing Products Control Program Help* file), the front panel buttons (see **Input Presets** on page 39, or SIS commands (see the **Input Presets** commands on page 65). The following settings are stored in input presets:

- Input Type
- Color
- Horizontal Start
- Horizontal Position
- Preset Name*
- Tint
- Vertical Start
- Vertical Position
- Film Mode Detect
- Contrast
- Pixel Phase
- Horizontal size
- Zoom
- Brightness
- Total Pixels
- Vertical size
- Pan
- DETAIL Filter

*Can be set only by SIS command

The 128 input presets are global, containing all of the settings for an input when the DVS is used with a matrix switcher. This allows a matrix switcher with multiple types of video inputs to be connected to the DVS 510 to expand the number of input video sources.

Each input should be switched into the DVS, configured, then saved as a preset for recall by a control system when that input is sent from the switcher to any of the 10 DVS inputs.

- If an input preset is recalled to an input that does not support the signal type saved in the preset, an SIS error code is returned.
- If the signal frequencies and total line count do not match the frequencies saved in the preset, the DVS uses the auto memories settings instead of recalling the preset. If no auto memories exist for the frequency, the DVS references its lookup table (a generic list of default sampling parameters embedded in the DVS).
- If the output rate does not match the output rate that was active when the preset was saved, all settings in the input preset are recalled **except** size and position.

To create an input preset:

- In the Input Selection section, click the button for the input for which you want to create the preset.
- Using the User Control page, SIS commands, or the front panel controls, make any desired changes to the input parameters that you want to save in the new preset.
- Click the **Presets** link on the left sidebar menu to display the Presets page.
- From the **Input Presets** drop-down menu, select a number for the new preset.
- Click the **Save** button.

To recall a saved input preset:

- From the **Input Presets** drop-down menu, select a preset number.
- Click the **Recall** button. The preset is applied to the current input.

PIP Setup Page

Use the PIP Setup page to configure the picture-in-picture window.

The screenshot shows the Extron Electronics web interface for the PIP Setup page. The header includes the Extron logo and navigation tabs: Status, Configuration, File Management, and Control. The user is logged in as Admin. The page title is "PIP Setup" for a "DVS 510 SA" device. On the left sidebar, "User Control Presets" is expanded, and "PIP Setup" is selected. The main content area is divided into three sections:

- PIP Selection:** A 2x5 grid of buttons numbered 1 through 10. Below the grid are three buttons: "SWAP", "OFF" (highlighted in blue), and "AUTO-IMAGE".
- Picture Control:** A grid of controls for image adjustment. Each control consists of a text label, a numeric input field (displaying "----"), and two buttons labeled "-" and "+". The controls are: Horizontal Shift, Vertical Shift, Horizontal Size, Vertical Size, Pan (with "U", "L", "R", and "D" buttons), Color, Tint, Brightness, Contrast, Detail Filter, and Zoom.
- Input Sampling:** A grid of controls for input parameters. Each control consists of a text label, a numeric input field (displaying "----"), and two buttons labeled "-" and "+". The controls are: Horizontal Start, Vertical Start, Pixel Phase, Total Pixels, Active Pixels, and Active Lines.

Figure 46. PIP Setup Page

On this screen, you can specify the parameters described on the next page for the PIP window.

Selecting a PIP input

The PIP input must be a different resolution type (high or low) from the main input. For example, if input 1 (composite video) is your main input, the PIP input can be selected from inputs 5 through 10 (high-resolution only). The following table shows the resolution type for each input:

Input	High Resolution	Low Resolution
1		Composite
2		Composite
3		S-video
4		S-video
5	RGB, YUVp/HDTV	YUVi, RGBcvS
6	RGB, YUVp/HDTV	YUVi, RGBcvS
7	RGB, YUVp/HDTV	YUVi, RGBcvS
8	DVI (all formats)	
9	RGB, YUVp/HDTV	YUVi, RGBcvS
10	DVI (all formats)	

By default, the PIP image is one-fourth the size of the main window and is positioned in the lower-right corner of the display. You can change this size using the controls on the **PIP Setup** page.

To select the PIP input:

1. If necessary, select the desired main input.
2. In the PIP Selection panel, click the desired input button. If your selection is valid, PIP mode is enabled and the PIP On/Off button on the front panel lights.

NOTE: Based on the currently selected main input, the buttons for inputs with the wrong type of resolution are grayed-out and unavailable.)

The PIP input button on the screen is highlighted and its equivalent input button on the front panel lights green.

NOTES:

- Audio or video breakaway is not available when the DVS is in PIP mode.
- Audio comes from either the main or the PIP input, depending on the current **Audio Follow** setting (the default is to follow the main window).

Other PIP control buttons include:

- **Swap** — Switches the active main window input with the PIP input. The button for the new PIP input is highlighted on the screen.
- **Off** — Exits PIP mode. The highlighting is removed from the PIP input button on the screen and the **off** button is highlighted. The PIP On/Off button on the front panel becomes unlit.
- **Auto-Image** — Performs an Auto-Image (adjusts the image to fill the screen) on the selected PIP input (see **Auto Image submenu** on page 30 for more information about the Auto-Image function).

Picture Control (PIP)

In the **Picture Control** panel, adjust the PIP controls as desired. Except for **Pan**, you can adjust these by either clicking the **+** or **–** button to increase or decrease the value in the text field, or by keying in a value.

- **Horizontal Shift** — Move the image to the right or left on the display. The value in the text box is the distance in pixels of the left edge of the image from the left edge of the display. The range is dependent on the output. The default is 0 plus or minus the output rate. (This is the same as horizontal positioning or centering.)
- **Vertical Shift** — Move the image up or down on the display. The value in the text box is the distance in lines of the top edge of the image from the top edge of the display. The range is dependent on the output. The default is 0 plus or minus the output rate. (This is the same as vertical positioning or centering.)
- **Horizontal Size** — Stretch or shrink the image horizontally. The value in the text box is the width of the image in pixels. The range is dependent on the output rate.
- **Vertical Size** — Stretch or shrink the image vertically. The value in the text box is the height of the image in lines. The range is dependent on the output rate.
- **Color** — Adjust the intensity of the colors in the image. (At the lowest adjustment, all colors appear as shades of gray.) The range is 000 through 127, the default is 064.
- **Tint** — Change the appearance of the colors in the selected window. The range is 000 to 127, the default is 064.
- **Brightness** — Set the black level of the input. The range is 000 through 127; the default is 064.
- **Contrast** — Increase or decrease the range of image light and dark values in the image. The range is 000 through 127, the default is 064.
- **Detail Filter** — Adjust the sharpness of the image in the image. The range is 000 through 127, the default is 064.
- **Zoom** — Increase or decrease the size of the image while keeping the aspect ratio constant. The range is dependent on the output rate.
- **Pan** — Click the **L** or **R** button to move the focus on the image left or right. Click **U** or **D** to pan up or down. Pan is available only if **Zoom** is set to greater than 100%.

Input Sampling (PIP)

The input sampling controls for the PIP window also can be adjusted by clicking the **+** or **–** button to adjust the value in the text field, or by keying in a value.

- **Horizontal Start** — Specify the distance in pixels from the left edge of the total display area of the selected input to the left edge of its active area. The default is 128.
- **Vertical Start** — Specify the distance in pixels from the top edge of the total video display area of the selected input to the top edge of its active area. The default is 128.
- **Pixel Phase (RGB and YUVp/HDTV inputs only)** — Adjust the point at which pixels are sampled for the selected input. The range is 1 through 31, the default is 16.
- **Total Pixels (RGB and YUVp/HDTV inputs only)** — Increase or decrease the width in pixels of the total line of video. The default is the auto-sensed value. The range is ± 512 from the auto-sensed value.
- **Active Pixels** — Increase or decrease the width in pixels of the active video area of the selected input. The default is the auto-sensed value. The range is ± 512 from the auto-sensed value.
- **Active Lines** — Increase or decrease the height in lines of the active video area of the selected input. The default is the auto-sensed value. The range is ± 512 from the auto-sensed value.

Reference Information

This section provides reference information on the DVS 510 Series. The following topics are covered:

- Mounting the DVS 510 Scaler
- Button Labels
- IP Addressing

Mounting the DVS 510 Scaler

Rack Mounting

UL guidelines for rack mounting

The following Underwriters Laboratories (UL) guidelines pertain to the installation of the DVS 510 in a rack:

- **Elevated operating ambient temperature** — If the equipment is installed in a closed or multi-unit rack assembly, the operating ambient temperature of the rack environment may be greater than room ambient. Therefore, consider installing the equipment in an environment compatible with the maximum ambient temperature (T_{ma}) specified by the manufacturer.
- **Reduced air flow** — Install the equipment in the rack so that the amount of air flow required for safe operation of the equipment is not compromised.
- **Mechanical loading** — Mount the equipment in the rack so that uneven mechanical loading does not create a hazardous condition.
- **Circuit overloading** — When connecting the equipment to the supply circuit, consider the effect that circuit overloading might have on overcurrent protection and supply wiring. Consider equipment nameplate ratings when addressing this concern.
- **Reliable earthing (grounding)** — Maintain reliable grounding of rack-mounted equipment. Pay particular attention to supply connections other than direct connections to the branch circuit (such as the use of power strips).

Rack mounting procedure

The DVS 510 scaler is delivered with MBD 249 mounting brackets attached. For optional rack mounting, do not install the rubber feet.

Mount the scaler in the rack as follows (see [figure 47](#) on the next page):

1. Insert the unit into the rack and align the holes in the mounting brackets with the holes in the rack.
2. Use four machine screws (provided) to attach the brackets to the rack.

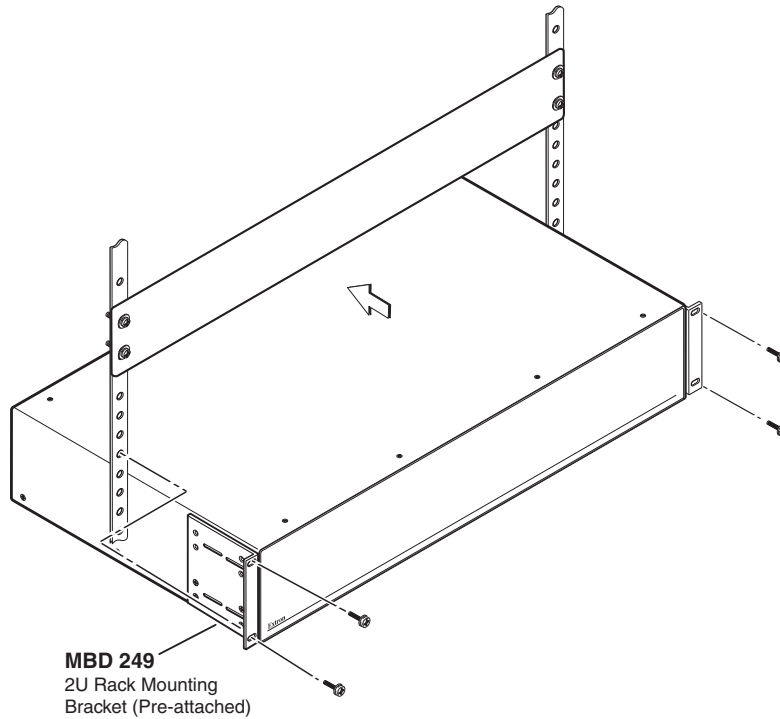

Figure 47. Rack Mounting a DVS 510 Scaler

Tabletop Use

To set up the unit for tabletop use:

1. Remove the eight screws to detach the mounting brackets from the sides of the unit.
2. Attach one of the provided self-adhesive rubber feet to each corner of the bottom of the unit.

Button Labels

The DVS 510 is delivered with button caps pre-labeled for your convenience. However, you can replace these labels with your own button labels, if desired. [Page 113](#) contains blank button labels. If desired, print the page and cut the labels out, write button information in each button area as desired, and insert them behind the transparent button caps. You can also create labels using the Button Label Generator software, provided with the DVS on the Extron software DVD.

Replacing Button Labels

The button assembly consists of a clear lens cap, the button label, and a white diffuser (see [figure 48](#) on the next page).

To replace a button label:

1. Make new labels as needed, using either the [blanks](#) on page 113 or the Button Label Generator software, and cut them out.
2. Remove the button assembly by inserting a small, flat-bladed screwdriver between the button base and the diffuser to gently pry the button assembly off the button plunger (see [figure 48](#), [2](#)).

3. Locate the small corner notch on the lens cap, and slide the screwdriver between the lens cap and the diffuser.
4. Using a rotating motion of the screwdriver, carefully pry the two pieces apart (see figure 48, ③).
5. Lift out the transparent square label that you want to replace. You may need to use the small screwdriver to gently pry the label out.
6. Insert one of the new labels you created in step 1 into the clear button cap, align the white backing plate with the cap, and firmly snap it into place.
7. Gently, but firmly, press the reassembled button into its space on the DVS front panel, until it snaps into place.
8. Repeat steps 1 through 7 as needed to relabel other buttons.

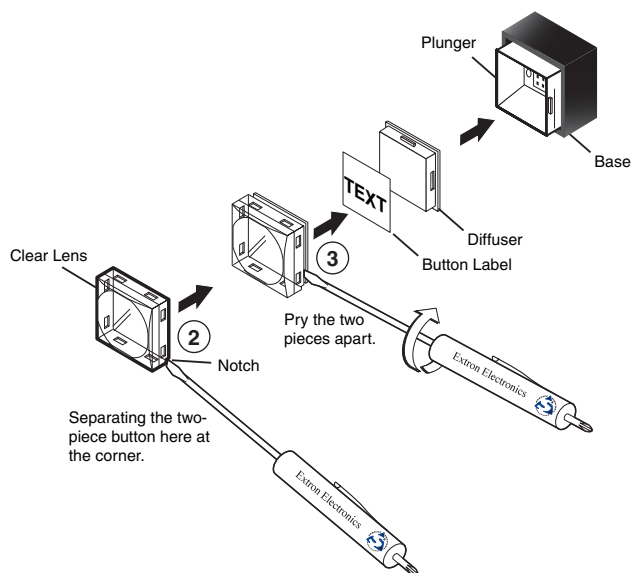

Figure 48. Replacing a Button Label

Creating Labels Using the Button Label Generator

The Button Label Generator software creates labels that you can place inside the transparent covers of the front panel buttons. You can create labels with names, alphanumeric characters, icons, and even colored bitmaps for easy and intuitive input and output selection (see [Replacing Button Labels](#) on the previous page for procedures for removing and replacing the button covers).



The program is contained on the same DVD as the Signal Processing Products Control Program, and is installed automatically when you install the control software. By default, the software installation creates a directory for the program at **C:\Program Files\Extron\ButtonLabelGenerator**. The **Button Label Generator** icon is placed in the Extron Electronics group or folder.

1. To run the label creation program, double-click on the **Button Label Generator** icon (shown at right) in the **Extron Electronics** group or folder. The **Button Label Generator** window opens.

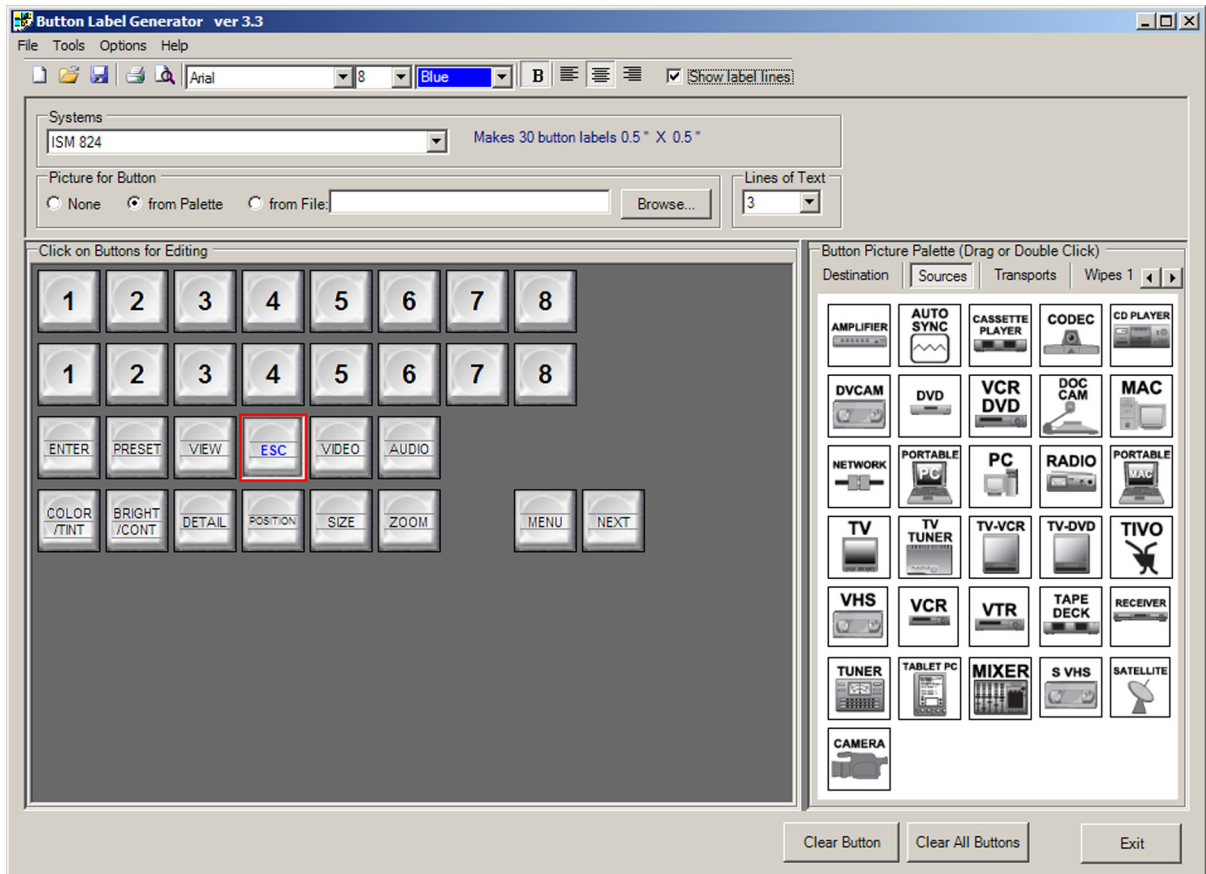

Figure 49. Button Label Generator Window (Example)

2. From the **Systems** pull-down menu, select a layout that most resembles the DVS 510 front panel buttons (although you can select any layout from this menu). You can also select **Customize Button Layouts** from the **Tools** menu to open the **Customize button layout** window, on which you can create your own layout.
3. Click on the button representation that you want to edit. A red box surrounds the selected button.
4. Edit the selected button by using any of the tools provided on the **Button Label Generator** window. Some of the edits you can make are:
 - Enter text and select the font, text size, and text color from the drop-down menus on the tool bar.
 - Select an icon from the **Button Picture Palette** and drag it to the desired button.
 - Place a bitmap image from your computer on a selected button.

To remove all the text or the image from a selected button, click **Clear Button**. To remove the text and images from all the buttons, click **Clear All Buttons**.

To access the *Button Label Generator Help*, select **Use Help** from the **Help** menu.

5. When finished creating the labels, print out your labels by selecting **Print** from the **File** menu in the upper-left corner of the **Button Label Generator** window.

To save the button labels as an .xml file on your computer, select **Save As** from the **File** menu and enter a name for the label file.

Blank Button Labels

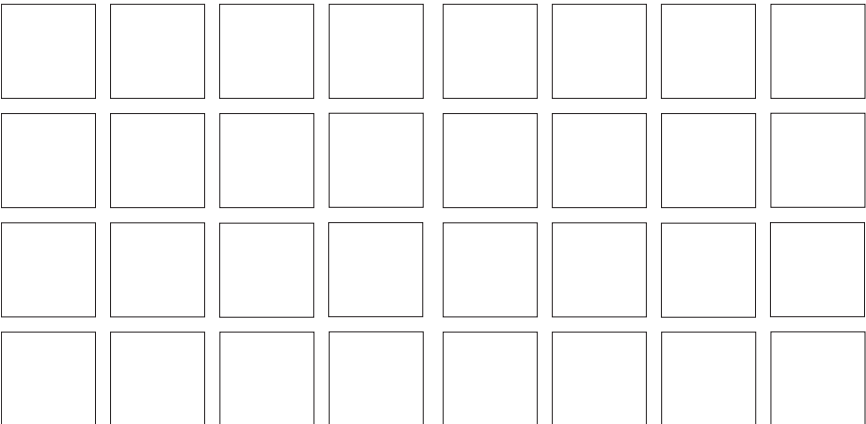
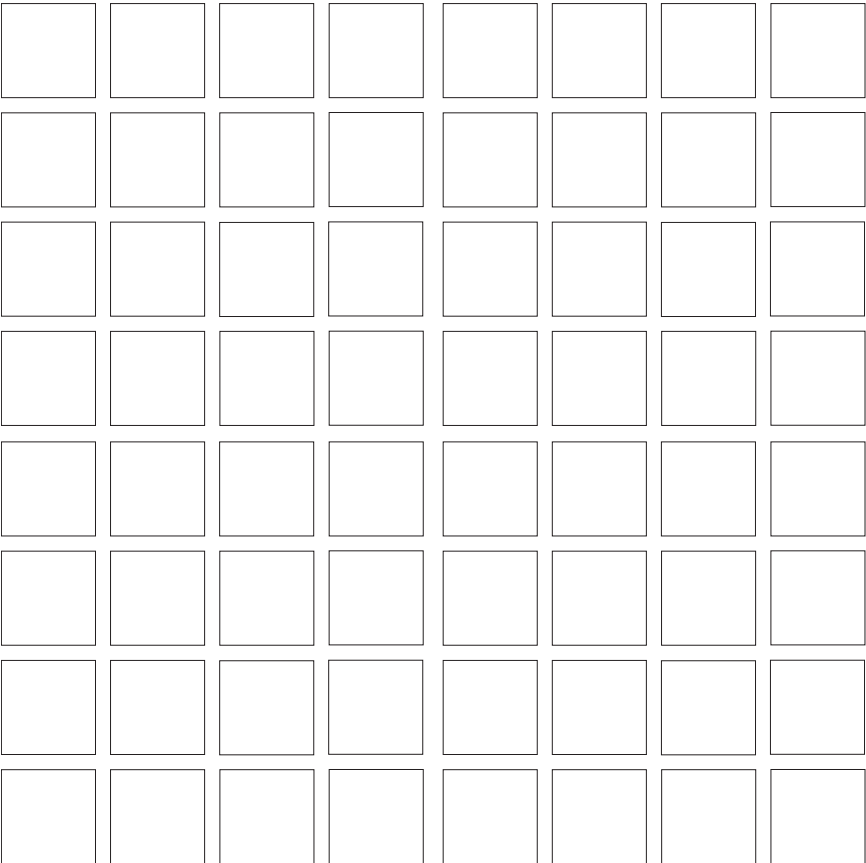
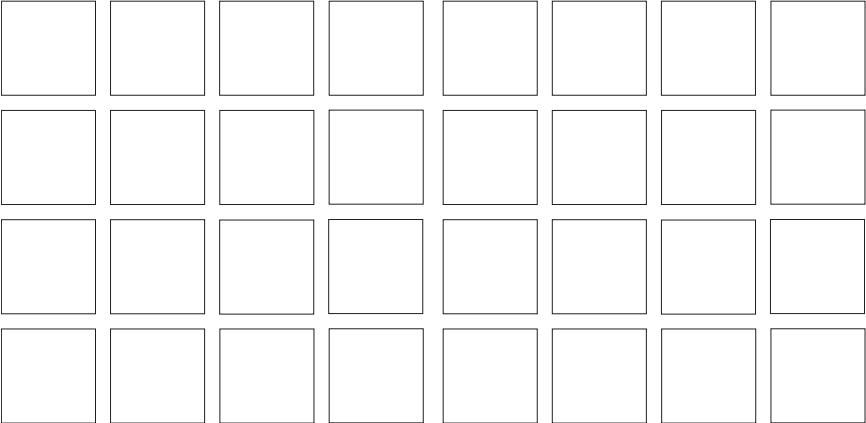

IP Addressing

What is an IP Address?

An IP address is a 32-bit binary number that is used to identify each device on an Ethernet network. This number is usually represented by four decimal numbers (each in the range of 0 to 255) separated by dots, such as 198.123.34.240. This is called “dotted decimal notation.”

An IP address is divided into two parts:

- Network identifier
- Host identifier

Each address on a given network must have the same network identifier value but a unique host identifier. As a result, there are different classes of addresses that define the range of valid addresses and which parts of the address are used for the network and host identifiers. The table below shows the most common IP address classes. In this table, NNN refers to the network identifier and HHH refers to the host identifier.

Class Name	Valid Address Range	Identifier Arrangement
Class A	0.0.0.1 to 127.255.255.254	NNN . HHH . HHH . HHH
Class B	128.0.0.1 to 191.255.255.254	NNN . NNN . HHH . HHH
Class C	192.0.0.1 to 223.255.255.254	NNN . NNN . NNN . HHH

Choosing IP Addresses

If the computer and the DVS are directly connected or connected via their own independent network, follow the guidelines below to choose the IP addresses.

However, if you intend to connect your computer and scaler to an existing network, you need to ask the network administrator to allocate suitable IP addresses.

On an independent network, it is generally recommended that you use the Class C format (from 192.0.0.1 to 223.255.255.254).

There are two rules for choosing IP addresses:

- The network identifier must be the same for each IP address.
- The host identifier must be unique for each address.

By these rules, the first three decimal values of your class C IP address must all be the same, while the last value is identifies each device.

The following is an example of a **valid** Class C addressing scheme:

Device	IP Address
SPPCP Control Software Computer	208.132.180.41
DVS 510	208.132.180.42

NOTE: The host identifiers (41 and 42 in the example above) do not need to be sequential or in any particular order. However, it is recommended that you group the numbers for simplicity.

The following is an example of an **invalid** Class C addressing scheme:

Device	IP Address
SPPCP Control Software Computer	208.132.180.41
DVS 510	192.157.180.42

NOTE: The above addresses are invalid because the network identifier for each address is not the same even though each IP address is unique.

You can perform a test from your computer to check that a device at a particular address is responding correctly or to determine its address (see “Pinging for the IP Address”).

Subnet Mask

The subnet mask is another 32-bit binary number that is used to “mask” certain bits of the IP address. This provides a method of extending the number of network options for a given IP address. It works by allowing part of the host identifier to be used as a subnet identifier.

It is important that you set the correct value for the subnet mask. The basic values depend on the class of IP address being used.

Class Name	Subnet Mask
Class A	255.0.0.0
Class B	255.255.0.0
Class C	255.255.255.0

(See [Subnetting, a Primer](#) on page 118 for more information.)

Pinging for the IP Address

To access the DVS 510 via the Ethernet port, you need the scaler IP address. If the address has been changed to an address comprised of words and characters, you can determine the actual numeric IP address using the Ping utility. If the address has not been changed, the factory-specified default is 192.168.254.254.

Ping can also be used to test the Ethernet link to the DVS 510 Series.

Pinging to determine the Extron IP address

The Microsoft Ping utility is accessed via the command prompt. Ping tests the Ethernet interface between the computer and the DVS 510 scaler. Ping can also be used to determine the actual numeric IP address from an alias and to determine the Web address.

Ping the scaler as follows:

1. In the lower-left corner of the computer screen, click the Windows **Start** icon.
2. In the **Search programs and files** field, enter **command**.
3. On the pop-up window that opens, click **Command Prompt**. A command prompt window opens.

4. At the command prompt, enter `ping IP address`. The computer returns a display similar to figure 50.

The line `Pinging ...` reports the actual numeric IP address, regardless of whether you entered the actual numeric IP address or an alias name.

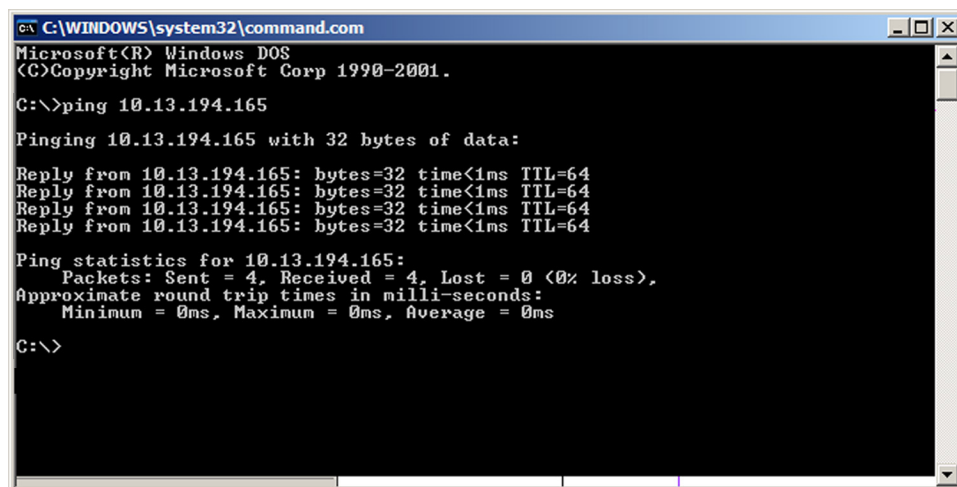

```
C:\WINDOWS\system32\command.com
Microsoft(R) Windows DOS
(C)Copyright Microsoft Corp 1990-2001.

C:\>ping 10.13.194.165

Pinging 10.13.194.165 with 32 bytes of data:

Reply from 10.13.194.165: bytes=32 time<1ms TTL=64
Reply from 10.13.194.165: bytes=32 time<1ms TTL=64
Reply from 10.13.194.165: bytes=32 time<1ms TTL=64
Reply from 10.13.194.165: bytes=32 time<1ms TTL=64

Ping statistics for 10.13.194.165:
    Packets: Sent = 4, Received = 4, Lost = 0 (0% loss),
    Approximate round trip times in milli-seconds:
        Minimum = 0ms, Maximum = 0ms, Average = 0ms

C:\>
```

Figure 50. Ping Command and Response

Pinging to determine the web IP address

The Ping utility has a modifier, `-a`, that directs the command to return the web address rather than the numeric IP address.

At the prompt, enter `ping -a IP address`. The display that the computer returns is similar to the Ping response shown in figure 50, except that when you enter `-a`, the `Pinging mail...` line reports the web IP address instead of the numeric IP address, regardless of whether you entered the actual numeric IP address or an alias name.

Connecting as a Telnet Client

The Microsoft Telnet utility is accessed via the command prompt. Telnet allows you to input SIS commands to the DVS from the PC via the Ethernet link and the LAN.

To start Telnet as follows:

1. In the lower-left corner of the computer screen, click the Windows **Start** icon.
2. In the **Search programs and files** field, enter `command`.
3. On the pop-up window that opens, click **Command Prompt**. A command prompt window opens.

4. At the prompt, enter `telnet`. The computer returns a display similar to figure 51.

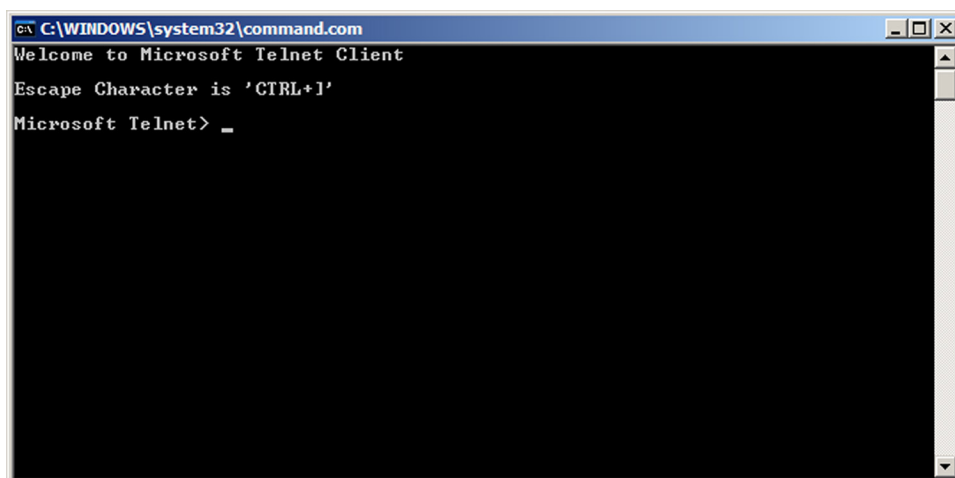

```
C:\WINDOWS\system32\command.com
Welcome to Microsoft Telnet Client
Escape Character is 'CTRL+I'
Microsoft Telnet> _
```

Figure 51. Telnet Screen

Telnet tips

It is not the intention of this guide to detail all of the operations and functionality of Telnet, however, some basic level of understanding is necessary for operating the DVS 510 Series via Telnet.

Connecting to the DVS (Open command)

Use the Open command to connect the computer to the DVS 510 scale. After the computer and scaler are connected, you can enter the SIS commands the same as you would if you were using the RS-232 or RS-422 link.

Connect the computer to the DVS as follows:

1. At the `Telnet` prompt, enter `open {IP address}`.
 - If the scaler is not password protected, no further prompts are displayed until you disconnect from the DVS.
 - If the scaler is password protected, Telnet displays a password prompt.
2. If necessary, enter the password at the prompt.

Connection to the scaler via Ethernet can be password protected. There are two levels of password: administrator and user.

- **Administrator** — A person logged on as an administrator has full access to all DVS scaling capabilities and editing functions.
- **User** — Users can select test patterns, mute or unmute the output, select a blue screen, and view all settings with the exception of passwords. By default, the scaler is delivered with both passwords set to “carriage return.”

When you are logged in, the scaler returns either **Login Administrator** or **Login User**. No further prompts are displayed until you disconnect from the DVS 510.

Escape character and <Esc> key

Many SIS commands include the keyboard <Esc> key. Consequently, some confusion may exist between the Escape character and the <Esc> key.

When Telnet is first started, the utility advises that the Escape character is <Ctrl+J>. This means that the Telnet Escape character is a key combination: the <Ctrl> key and the <J> key pressed simultaneously. Pressing these keys displays the `Telnet` prompt while leaving the connection to the DVS intact.

Local echo

Once your computer is connected to the DVS 510, by default Telnet does not display your keystrokes on the screen. SIS commands are entered blindly, and only the SIS responses are displayed on the screen. To command Telnet to show all keystrokes, enter `set local_echo` at the `Telnet` prompt before you open the connection to the scaler.

With local echo turned on, keystrokes and the scaler responses are displayed on the same line.

Example: `1*1!In1 Out1 All,`

where `1*1!` is the SIS command and `In1 Out1 All` is the response.

Note that all keystrokes are displayed, even those that should be masked, such as the password entry. For example, when entering a password with local echo turned on, you see a display such as `a*d*m*i*n*`, where `admin` is the keyed-in password and `*****` is the masked response.

Local echo can be turned off by entering `unset local_echo` at the `Telnet` prompt. If your computer is connected to the DVS, and you need to access the `Telnet` prompt to turn local echo off, enter the Escape sequence (`<Ctrl +] >`).

Setting carriage return with line feed

Unless commanded otherwise, Telnet transmits a line feed character only (no carriage return) to the connected scaler when you press the `<Enter>` key. This is the correct setting for SIS communication with the scaler. The `Telnet set crlf` command forces Telnet to transmit carriage return and line feed characters when `<Enter>` is pressed. However, if `crlf` is set, the SIS link with the scaler does not function properly.

Closing the link to the scaler

To close the link to the scaler, access the `Telnet` prompt by entering the Escape sequence (`<Ctrl +] >`). At the `Telnet` prompt, enter `close`.

Help

For Telnet command definitions, enter `?` at the Telnet prompt.

Exiting Telnet (Quit command)

Exit the Telnet utility by entering `quit` at the `Telnet` prompt. If you are connected to the DVS, access the `Telnet` prompt by entering the Escape sequence (`<Ctrl +] >`).

Subnetting, a Primer

A subnet is a **subset** of a **network** — a set of IP devices that have portions of their IP addresses in common. It is not the purpose of this manual to describe TCP/IP protocol in detail. However, some understanding of TCP/IP subnetting is necessary in order to understand the interaction of the DVS 510 and the mail server gateway. To understand subnetting at the level required to install and operate the DVS 510, you must understand the concepts of a gateway, local and remote devices, IP addresses and octets, and subnet masks and octets.

Gateways

The DVS 510 Series can communicate with the e-mail server that it uses for e-mail notification directly (if they are on the same subnet), or its communication can be routed via a gateway (a computer that provides a link between different subnets).

Local and remote devices

The local and remote devices are defined from the point of view of the function being described. In this guide, subnetting is an issue when you are using the controlling computer to set TCP/IP and e-mail values in the DVS (see [Establishing an Ethernet Connection Using TCP](#) on page 49). When you are setting up the variables for e-mail notification, the scaler is the local device and the e-mail server is the remote device.

IP addresses and octets

Valid IP addresses consist of four 1-, 2-, or 3-digit numeric sub-fields, called “octets,” which are separated by dots (periods) (see the illustration at right). Each octet can be numbered from 000 through 255. Leading zeros, up to three digits total per octet, are optional. Values of 256 and above are invalid.

Typical IP Address: 192,168,254,254
Octets

Subnet masks and octets

The subnet mask (figure 52) is used to determine whether the local and remote devices are on the same subnet or different subnets. The subnet mask consists of four numeric octets separated by dots. Each octet can be numbered from 000 through 255. Leading zeros, up to three digits total per octet, are optional. Each octet typically contains either 255 or 0. The octets determine whether or not the same octets of two IP addresses will be compared when determining if two devices are on the same subnet.

255 indicates that this octet will be compared between two IP addresses. 0 indicates that this octet will **not** be compared between two IP addresses.

Typical Subnet Mask: 255,255,0,0
Octets

Figure 52. Subnet Mask and Octets

Determining whether devices are on the same subnet

To determine the subnet, the local device IP address is compared to the remote device IP address (see figure 53). The octets of each address are compared or not, depending on the value in the related subnet mask octet.

- If a subnet mask octet contains the value 255, the related octets of the local device address and the remote device IP address are unmasked.
Unmasked octets are compared (indicated by ? in figure 53).
- If the subnet mask octet contains the value 0, the related octets of the local device and remote device IP addresses are masked.
Masked octets are not compared (indicated by X in figure 53).

If the unmasked octets of the two IP addresses match (indicated by = in example 1 of figure 53), the two addresses are on the same subnet.

If the two unmasked fields do not match (indicated by an unequal sign (≠) in figure 53, examples 2 and 3), the addresses are not on the same subnet.

	Example 1	Example 2	Example 3
Local IP Address:	192.168.254.254	192.168.254.254	192.168.254.254
Subnet Mask:	255.255.0.0 (??.X.X)	255.255.0.0 (??.X.X)	255.255.0.0 (??.X.X)
Remote IP Address:	192.168.2.25	190.190.2.25	192.190.2.25
Match?:	= . = .X.X — Match (Same subnet)	≠ . ≠ .X.X — No match (Different subnet)	= . ≠ .X.X — No match (Different subnet)

Figure 53. Comparing the IP Addresses

Extron Warranty

Extron Electronics warrants this product against defects in materials and workmanship for a period of three years from the date of purchase. In the event of malfunction during the warranty period attributable directly to faulty workmanship and/or materials, Extron Electronics will, at its option, repair or replace said products or components, to whatever extent it shall deem necessary to restore said product to proper operating condition, provided that it is returned within the warranty period, with proof of purchase and description of malfunction to:

**USA, Canada, South America,
and Central America:**

Extron Electronics
1230 South Lewis Street
Anaheim, CA 92805
U.S.A.

Japan:

Extron Electronics, Japan
Kyodo Building, 16 Ichibancho
Chiyoda-ku, Tokyo 102-0082
Japan

Europe and Africa:

Extron Europe
Hanzeboulevard 10
3825 PH Amersfoort
The Netherlands

China:

Extron China
686 Ronghua Road
Songjiang District
Shanghai 201611
China

Asia:

Extron Asia Pte Ltd
135 Joo Seng Road, #04-01
PM Industrial Bldg.
Singapore 368363
Singapore

Middle East:

Extron Middle East
Dubai Airport Free Zone
F13, PO Box 293666
United Arab Emirates, Dubai

This Limited Warranty does not apply if the fault has been caused by misuse, improper handling care, electrical or mechanical abuse, abnormal operating conditions, or if modifications were made to the product that were not authorized by Extron.

NOTE: If a product is defective, please call Extron and ask for an Application Engineer to receive an RA (Return Authorization) number. This will begin the repair process.

USA: 714.491.1500 or 800.633.9876

Asia: 65.6383.4400

Europe: 31.33.453.4040

Japan: 81.3.3511.7655

Units must be returned insured, with shipping charges prepaid. If not insured, you assume the risk of loss or damage during shipment. Returned units must include the serial number and a description of the problem, as well as the name of the person to contact in case there are any questions.

Extron Electronics makes no further warranties either expressed or implied with respect to the product and its quality, performance, merchantability, or fitness for any particular use. In no event will Extron Electronics be liable for direct, indirect, or consequential damages resulting from any defect in this product even if Extron Electronics has been advised of such damage.

Please note that laws vary from state to state and country to country, and that some provisions of this warranty may not apply to you.

Extron Headquarters +1.800.633.9876 (Inside USA/Canada Only) Extron USA - West +1.714.491.1500 +1.714.491.1517 FAX	Extron USA - East +1.919.850.1000 +1.919.850.1001 FAX	Extron Europe +800.3987.6673 (Inside Europe Only) +31.33.453.4040 +31.33.453.4050 FAX	Extron Asia +65.6383.4400 +65.6383.4664 FAX	Extron Japan +81.3.3511.7655 +81.3.3511.7656 FAX	Extron China +86.21.3760.1568 +86.21.3760.1566 FAX	Extron Middle East +971.4.299.1800 +971.4.299.1880 FAX	Extron Australia +61.8.8113.6800 +61.8.8351.2511 FAX	Extron India 1800.3070.3777 (Inside India Only) +91.80.3055.3777 +91.80.3055.3737 FAX
---	--	--	--	---	---	---	---	--